

OFFERS A VARIETY OF **TUBS** AND **SHOWERS?**

HAS **WATER HEATERS** FOR MY SIZE AND BUDGET?

CARRIES **A LARGE INVENTORY** OF MOBILE HOME PARTS?

SUPPLIES THE **FITTINGS** AND **VALVES** I NEED?

THE ANSWER IS



# WATER HEATERS



- Rheem exclusive R-tech (resistored) anode rod provides long-lasting tank protection.
- Field convertible controls and burner assembly for natural gas or LP operation included.
- HUD units compliant with H.U.D., ASHRAE 90A-80 and NAECA requirements.
- HUD gas units feature Piezo ignition – easy light pilot, no matches required.
- Single and double elements available on HUD units. High efficiency resistored heating element in single element models. Lifeguard stainless steel element in all double element models.
- Electric junction box located above heating elements for easy installation.
- Automatic thermostat keeps water at desired temperature HUD units feature Rheemglass tank lining that resists corrosion and prolongs tank life. EverKleen™ self cleaning device fights harmful sediment build-up with a high-velocity spiraling water stream – helps operating efficiency by saving energy, money and improving tank life.
- Enhanced-flow brass drain valve.
- Temperature and pressure relief valve included.
- Low lead compliant.



## Electric

STOCK #	U.S. GAL.	# OF ELEMENTS	VOLTS	SHIP WEIGHT	CONN.	HEIGHT (INCHES)	DIA.	WATTS/ BTU
WARRIOR 1 YEAR WARRANTY - HUD APPROVED								
0431705	30	2	240	70	SIDE	45-1/2"	17-3/4"	3500
0431739	30	2	240	91	SIDE	30"	21-3/4"	4500
0431738	30	1	120	91	SIDE	30"	21-3/4"	1700
0431712	40	2	240	94	TOP	46-1/2"	19-3/4"	4500
0431714	40	2	240	94	SIDE	46-1/4"	19-3/4"	4500
0431711	40	2	240	94	SIDE	46-1/4"	19-3/4"	3500
0431718	50	2	240	105	TOP	57"	19-3/4"	4500
0431701	50	2	240	105	SIDE	57"	19-3/4"	4500

PROFESSIONAL CLASSIC SERIES, 6 YEAR WARRANTY - HUD APPROVED								
0431704	19.9	1	120	62	SIDE	31-1/2"	17-3/4"	1500
0431706	30	2	240	80	SIDE	45-1/2"	17-3/4"	4500
0431742	30	1	240	70	SIDE	45-1/2"	17-3/4"	3500
0431743	40	1	240	94	SIDE	46-1/4"	19-3/4"	3500
0431715	40	2	240	94	SIDE	46-1/4"	19-3/4"	4500
0431702	50	2	240	108	SIDE	57"	19-3/4"	4500

PROFESSIONAL CLASSIC SERIES, 6 YEAR WARRANTY								
0431703	19.9	1	120	69	SIDE	25-1/4"	19-3/4"	1500
0431708	30	2	240	83	TOP	30"	22-1/4"	4500
0431710	30	1	120	83	TOP	30"	22-1/4"	1500
0431740	30	2	240	91	SIDE	30"	21-3/4"	4500
0431741	30	1	120	83	SIDE	30"	21-3/4"	1500
0431717	38	2	240	108	TOP	31-1/2"	23"	4500
0431756*	40	2	240	104	TOP	46-3/4"	22-1/4"	4500
0431735	40	2	240	95	TOP	46-1/2"	19-3/4"	4500
0431736	40	2	240	95	TOP	59-1/4"	19-3/4"	4500
0431719	50	2	240	117	TOP	46"	21-3/4"	4500
0431757*	50	2	240	128	TOP	46"	24-1/4"	4500

\* Classic Plus Provides higher energy factors and 8 year warranty.

## Natural\* Gas Sealed Combustion Direct Vent

PROFESSIONAL CLASSIC DIRECT VENT MODELS, 6 YEAR WARRANTY- HUD APPROVED								
0431724	30	N/A	N/A	110	SIDE/TOP	57"	17-3/4"	30,000
0431726	40	N/A	N/A	125	SIDE/TOP	57-1/2"	19-3/4"	30,000
0431730	50	N/A	N/A	165	SIDE/TOP	57"	21-3/4"	30,000

## Natural\*

PROFESSIONAL CLASSIC ATMOSPHERIC MODELS, 6 YEAR WARRANTY - HUD APPROVED								
0431721	29	3" VENT		100	SIDE/TOP	59-3/4"	16-1/8"	30,000
0431723	40	3" VENT		120	SIDE/TOP	61-3/4"	18-1/8"	32,000

\*Field convertible controls and burner assembly for natural or LP operation included.

## ADJUSTABLE ROOF JACK VENT

Design allows adjustment to roof pitches of up to 5/12".

- 0431748 12"                      0431750 30" - 60"
- 0431749 16" - 32"



## SCREW-IN IMMERSION

1" NPT no-taper screw plug. Fits many models of Rheem, State, Ruud, Norge and others. Includes one gasket.



- 0431600 1750W-120V; 25/CTN.      0431603 3500W-240V; 50/CTN.
- 0431601 1500W-120V; 25/CTN.      0431604 2000W-120V; 25/CTN.
- 0431602 4500W-240V; 50/CTN.      0431607 3000W-240V; 12/CTN.

## SQUARE FLANGE

2-1/2" square, flat surface, 2-1/2" bolt circle, 1-49/64" bolt centers. Includes one gasket. 50/Ctn.



- 0430702 1500W-120V; 50/CTN.

## UNIVERSAL FLANGE

2-1/2" square flange with raised corners. 2-1/2" bolt circle, 1-49/64" bolt centers. Includes one regular "O" ring. 25/Ctn.



- 0431203 4500W-240V

## WATERWAY CONNECTOR

For water heater inlet and outlet hookup plus other uses, where dissimilar metals occur in piping and plumbing systems. 3/4" MPT x 3/4" MPT x 3" length MIP. Thermoplastic lining prevents corrosion. Bulk.

- 0431625



## T & P VALVE

Temperature and pressure relief valve with test lever, stainless steel spring and all bronze body. Thermostat is positive, accurate and proven. Self-closing. 50/Ctn.



- 0430120 3/4" X 4" L      0432048 3/4" X 5" L      0432046 1/2" X 4" L

## T-STAT

Replacement for any electric, domestic water heater.

- 0431901 DOUBLE-THROW 240V
- 0431904 THERMO DISC 1-POLE
- 0431906 LOWER THERMOSTAT.



## CONTINUITY TESTER

Tests elements and thermostats while they are in the water heater. LED light indicates continuity. Unbreakable body with protective covers over light and probe.

- 0382006 12/CTN.



## OPEN COIL ELEMENTS

Seven porcelain discs. Stainless steel rod withstands 1300° constant temperature, and the machine-twisted terminal loops insure against burnouts. 50/Ctn.



- 0430503 1500W-120V
- 0430502 1750W-120V

## WATER HEATER DOOR

- |                   |                        |
|-------------------|------------------------|
| WITHOUT VENTS     | WITH VENTS (NOT SHOWN) |
| 0212000 22" X 60" | 0432050 22" X 60"      |
| 0211997 23" X 60" | 0211999 23" X 60"      |



## RESISTORED STAINLESS STEEL HEATING ELEMENTS

Feature a low watt density design with an outer sheath of Incoloy® 800 to resist failure from "dry firing". Built in resistor helps prolong anode life for greater tank protection and longer working life.

- 0431751 3500 LOWER
- 0431752 3500 UPPER
- 0431753 4500 LOWER
- 0431754 4500 UPPER



## FLEXIBLE WATER CONNECTORS

Flexible copper connector for water only.



0440015 24"; 25/CTN. 0440010 18"; 25/CTN. 0440018 WASHER

## FLEXIBLE GAS CONNECTORS

1/2" OD coated brass tubing 1/2" FPT x 1/2" MPT (tapped 3/8" FPT). Approved for indoor and outdoor use. AGA listed.



0250815 18" 0250816 24" 0250817 36"

## PEX WATER HEATER SWIVEL CONNECTORS

3/4" insert x 3/4" FPT for PEX tubing & pipe.

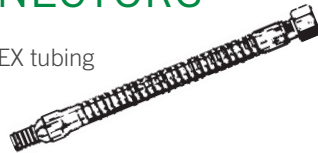

0440017

## SHARK BITE PUSH-ON WATER HEATER CONNECTOR

0440012 3/4" FIP X 3/4" SHARK BITE X 24" LONG

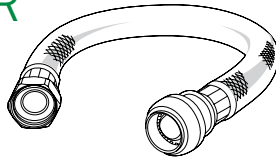

## COPPER WATER HEATER CONNECTION

Best Pex 18" color flex set 3/4" x 3/4" FPT, swivel



0440011 RED/BLUE SET.

## DRIP PAN

Plastic polymer, semi-flexible. Pre-drilled to accept furnished 1" PVC plastic fitting. Meets requirement of Southern Building Code.



0260155 22"; 12/CTN. 0260156 24"; 12/CTN.

## FROST KING WATER HEATER INSULATION

Vinyl-backed Fiberglass Insulation is designed for gas, oil, and electric water heaters up to 60-gallon capacity. Available in a choice of thicknesses to offer you greater R-values.



0270500 2" THICK X 48" X 75" R6.7  
0270501 3" THICK X 48" X 75" R10

## NIAGARA WATER HEATER BLANKET WITH TOP

This R-11 insulation blanket includes adhesive tape, easy to follow instructions, and is compatible with gas, oil, and electric water heaters. It can reduce energy loss by 25-45%, resulting in substantial monetary savings.



0270507 3" X 48" X 87"  
0270510 3" X 48" X 75"

## WATER HEATER THERMOCOUPLE

Fully universal. Fits push-in, screw-in or clamp-on type pilot burners. 24/Ctn.



0232501 18" 0232502 24" 0232503 30"

## GAS VALVE

Convertible gas valve for mobile home heaters. 1-1/2" shank.



0430415 SEALED COMBUSTION 0430416 ATMOSPHERIC

## WATER HEATER RUN OFF TUBE

0430401 SIDE MOUNT  
0430402 TOP MOUNT





## FIBERGLASS STANDARD TUB

A sloped bathing well makes efficient use of small space with a clean, simple design. Slip-resistant, textured floor. Complies with NAHB, HUD UM-73A, and ANSI-Z124.1. 3 year warranty - left or right hand drain. Dimensions: 54"W x 28.25"D x 17.5"H.

### WHITE

0379071 WHITE - LH TUB\*

0379073 WHITE - RH TUB\*

0378201 - ENCLOSURE FOR 54" TUB

(\*Note: These models do not have pre-drilled overflow hole.) Not Stocked At All Locations

### BONE

0379070 BONE - LH TUB\*

0379072 BONE - RH TUB\*



0379071 Shown Above

## FIBERGLASS GARDEN TUB

A relaxing bathing experience awaits in this bath. Fixtures can be placed on the left or right surrounding ledges. Slip-resistant, textured floor. A natural for whirlpool, this unit can be jetted. Center drain. 3 year warranty. Complies with NAHB, HUD UM-73A, and ANSI-Z124.1

### WHITE -WITH STEP

0379935 WHITE - 54"W X 42"D X 24.75"H\*

### BONE - WITH STEP

0379936 BONE - 54"W X 42"D X 24.75"H\*

(\*Note: These models do not have pre-drilled overflow hole.) Not Stocked At All Locations



## 2-PC. SURROUND, PLUS TUB OR SHOWER PAN

This 2-Piece Surround & Tub/Shower Pan has fiberglass reinforced gelcoat construction and molded soap ledges. Slip-resistant, textured floor. 3 year warranty.

Dimensions: 54" Wide x 28" Deep. Tub Surround is 75" high and shower surround is 75.5" high. Complies with NAHB, HUD UM-73A, and ANSI-Z124.1 (Shower Pans Comply with ANSI-Z124.2)

### WHITE

0379081 WHITE, CENTER DRAIN, TUB/SHOWER

0379084 WHITE, CENTER DRAIN, SHOWER PAN

0379945 WHITE, CENTER DRAIN, SHOWER PAN WITH PRE-DRILLED 2-1/2" OVERFLOW

0379086 WHITE, LH DRAIN, TUB/SHOWER

0379087 WHITE, RH DRAIN, TUB/SHOWER 3-PC 29" X 54"

0378201 ENCLOSURE FOR 54" TUB

0378206 ENCLOSURE FOR 54" SHOWER PAN

### BONE

0379080 BONE, CENTER DRAIN, TUB/SHOWER

0379085 BONE, CENTER DRAIN, SHOWER PAN

0379088 BONE, LH DRAIN, TUB/SHOWER

0379089 BONE, RH DRAIN, TUB/SHOWER



0379081 Shown Above

(\*Note: Unless specified, these models do not have pre-drilled overflow hole.) Not Stocked At All Locations

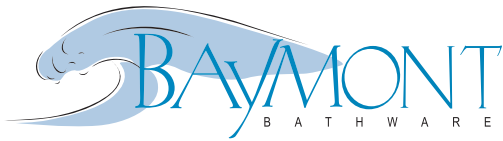

Baymont Bathware is a leading brand of showers and tubs for the selective homeowner, contractor or interior designer. Blevins extensive product line up is made with durable materials that will enhance the beauty of any bath for years to come. We also offer many styles of assisted care and accessible living bathware. Products are built with quality materials and are backed by our extensive warranty.

Baymont uses only sanitary high-grade gloss polyester gelcoat, reinforced with composite matrix. The finish, Baymont Sanitary White, is a proprietary color containing UV and mold inhibitors. 3" legs are built into the design for stability; a ridge trim protects the Apron and eliminates shoe molding. Baymont does not use cardboard or other undesirable structural materials. Units are constructed of polyester resins and strand glass only. Bottoms are constructed of A-Grade 7/16 OSB for better adhesion and stronger foundation.

Certifications: ANSI Z124.2

## LIFESTYLE TUB

27" Bath Tub – 27" x 54".

- Elegant body lines in surround and skirt
- Larger bowl –deeper, longer, wider
- Same surround fits all units
- Wall surround sold separately

### WHITE

0377878 27" X 54" TUB, RH DRAIN

0377879 27" X 54" TUB, LH DRAIN

0377880 27" X 54" TUB, CENTER DRAIN

### BONE

0377875 27" X 54" TUB, RH DRAIN

0377876 27" X 54" TUB, LH DRAIN

0377877 27" X 54" TUB, CENTER DRAIN



## MYLA TWO PIECE WALL SURROUND

53.75" x 27.5" x 57" with flange. Fits 27" x 54" tub and pan. The unit is made of sanitary grade high gloss polyester gelcoat with reinforced composite matrix. Integrated soap dish in the surround. Pictured above with tub.

### WHITE

0377885

### BONE

0377886



## CODY BATH TUB

27" Bath Tub – 26.5" x 53.75" x 17" with flange. Total capacity: 37 gallons. Slip resistant floor.

### WHITE

0377852 27" X 54" TUB, RH DRAIN  
0377850 27" X 54" TUB, LH DRAIN

### BONE

0377853 27" X 54" TUB, RH DRAIN  
0377851 27" X 54" TUB, LH DRAIN



Right Hand Drain

## CADE BATH TUB

27" Bath Tub – 26.5" x 53.75" x 17" with flange. Total capacity: 37 gallons. Slip resistant floor.

### WHITE

0377858 27" X 54" TUB, CTR BACK DRAIN

### BONE

0377859 27" X 54" TUB, CTR BACK DRAIN



Center Drain

## CASEY SHOWER PAN

27" Shower Pan – 26.5" x 53.75" x 19" w/flange. Slip resistant floor. Above floor rough-in.

### WHITE

0377866 27" X 54" SHOWER PAN, CTR BACK DRAIN

### BONE

0377867 27" X 54" SHOWER PAN, CTR BACK DRAIN



Center Drain

## PIEDMONT DROP-IN TUB

60" x 42" x 23.5" with flange. Total capacity: 48 gallons. Slip resistant floor. Above floor rough-in. Available in whirlpool by special order.

### WHITE

0377898



## PRE-FABRICATED TILE WALL KIT

Pre-Fabricated Tile Wall Surrounds are manufactured using the same materials you would use if custom building on site:

- Concrete fiber board
- Thin set mortar
- High quality porcelain tile
- Epoxy sanded grout

Quick install saving you time and money.

The standard kit is built to fit our Casey Shower Pan and the Garden Tub kit fits our Bella Tubs (next page).

0377901 FOR STANDARD TUB

0377900 FOR STANDARD TUB INCLUDES DECORATIVE ACCENT BAND

0377903 FOR GARDEN TUB

0377902 FOR GARDEN TUB INCLUDES DECORATIVE ACCENT BAND



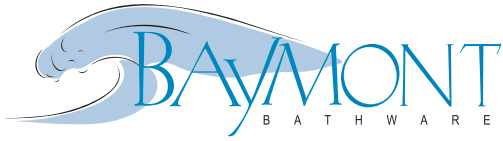

## PROVIDENCE GARDEN TUB

60" Garden Tub With Step – 59.75" x 49" x 23-1/2" H with flange. Total capacity: 58 fallons. Slip resistant floor. Available in whirlpool by special order.

**WHITE**

0377863 60" X 49" GARDEN TUB WITH STEP

**BONE**

0377862 60" X 49" GARDEN TUB WITH STEP



Center Drain

## RIDGEWOOD GARDEN TUB

54" Garden Tub With Step & No Walls – 53.75" x 45" x 24" H with flange. Total capacity: 49 gallons. Slip resistant floor. Available in whirlpool by special order.

**WHITE**

0377865 54" X 45" GARDEN TUB WITH STEP

**BONE**

0377864 54" X 45" GARDEN TUB WITH STEP



Center Drain

## MILLTOWN GARDEN TUB

60" Garden Tub, No Step, No Wall – 59.5" x 42.25" x 25.5" H with flange. Total capacity: 75 gallons. Slip resistant floor. Available in whirlpool by special order.

**WHITE**

0377861 60" X 42" GARDEN TUB

**BONE**

0377860 60" X 42" GARDEN TUB



Center Drain

## BELLA 54" GARDEN TUB

54" Garden Tub With Step – 54" x 42" x 24.75" with flange. One piece construction. Slip resistant floor.

**WHITE**

0377881 54" X 42.25" WITH STEP

**BONE**

0377882 54" X 42.25" WITH STEP

0377887 MATCHING WALL SURROUND

0377888 MATCHING WALL SURROUND



Center Drain



## MARSHALL CORNER TUB

54" Corner Tub – 54.25" x 54.25" x 20.75". Total capacity: 74 gallons. Slip resistant floor. Above floor rough-in. Skirted, right hand drain, with step and access panels. Available in whirlpool by special order.

**WHITE**  
0377884



## MCCARRON SHOWER PAN

48" One Seat Shower Pan – 47.75" x 34.5" x 25.5". One piece construction. One seat. Slip resistant floor.

**WHITE**  
0377891



## OLIVIA SHOWER PAN

60" x 42" One Seat Shower Pan – 59.75" x 42" x 25.5" with flange. One piece construction. One seat. Slip resistant floor.

**WHITE**  
0377889 60X42 SHWR PAN W/LEFT SEAT



## GABBY 32" 1 PC. SHOWER

31-1/2" x 31-1/2" x 75" rough in size, w/flange. Available with a pre-installed pivot shower door by special order.

**WHITE**  
0377871

**BONE**  
0377872



## 32" THREE PART SHOWER

32" x 32" x 74" rough in size, w/flange. Center drain. Slip resistant floor. Sanitary grade high gloss polyester gelcoat with reinforced composite matrix.

**WHITE**  
0377874 WHITE  
0377873 WHITE PAN, NO SURROUND

**BONE**  
0377883 BONE

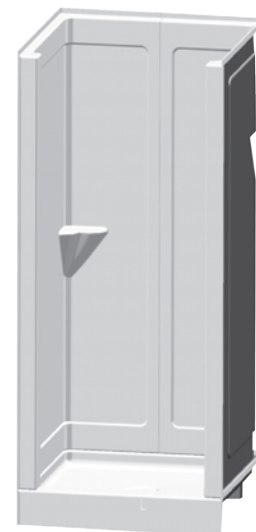

# MAAX®

Enjoy the experience

## 29" X 54" SHOWER PAN

Molded from gel coat fiberglass and fully reinforced with fiberglass backing. Textured floor pattern. Anti-flex floor construction. Complies with ANZI Z 124 Series and HUD/FHA-UM-73a.

**WHITE**  
0379866

**BONE**  
0379867



## 33" X 33" SHOWER STALL

Comes complete with "no caulk" drain, plastic faucet, shower head, handrail, soap dish and curtain. One-piece heavy-gauge plastic walls install quickly without caulk or fitting. Resists mildew and rust. White. 7.0 cubic feet, 33" x 72-3/8" x 33", 27" opening.

**WHITE**  
0379024 33X33

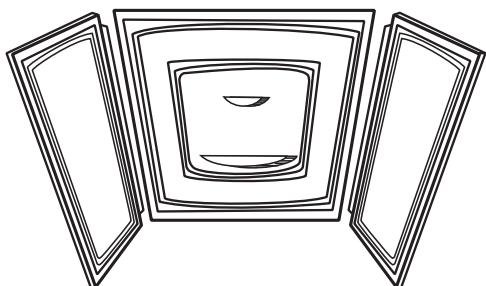

## 3-PC. ABS WALL SURROUND

Three piece bath wall featuring two convenient shelves. Interlocking panels with smooth gloss finish. 27" D x 54" W x 59.5" H.

**WHITE**  
0379855

**BONE**  
0379856

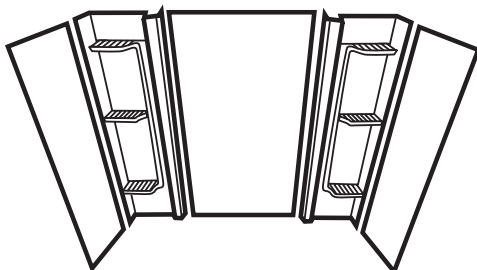

## 5-PC. SURROUNDS

Five piece bath wall featuring six convenient shelves. High-gloss finish. 27" D X 54" W X 59" H.

**WHITE**  
0379917

**BONE**  
0379916

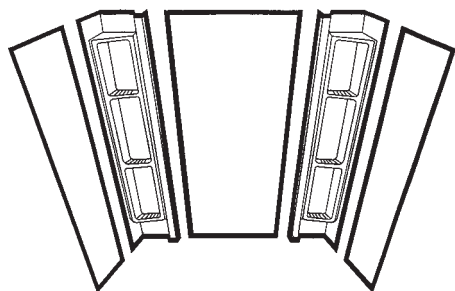

## 5-PC. GARDEN-TUB SURROUNDS

Five piece bath wall featuring six convenient shelves. High-gloss finish. Easily cut to fit depths from 42" to 48".

**WHITE**  
0379056 60" W X 59" H

**BONE**  
0379058 60" W X 59" H

These tubs and surrounds are made of ABS plastic and come in calf-grain textures. The strength in these tubs come from injection molded foam bases and formed drain supports. Garden tubs have an additional Masonite bottom sheet for stability. One-year warranty on standard tubs; heavy-duty units have a five-year warranty. Other tub styles and sizes are available by special order.

## STANDARD TUB WITH LEFT OR RIGHT HAND DRAIN

27" x 54" x 15-7/16" H (12" Depth)

### WHITE

0379984 LH WHITE  
0379985 RH WHITE  
0379875 LH WHITE, BOXED  
0379876 RH WHITE, BOXED

### ALMOND

0379978 LH ALMOND  
0379979 RH ALMOND  
0379877 LH ALMOND, BOXED  
0379878 RH ALMOND, BOXED



## STANDARD TUB WITH CENTER DRAIN

27" x 54" x 14-7/8" H (11-3/8" Depth)

### WHITE

0379997 WHITE  
0379999 WHITE, BOXED

### ALMOND

0379998 ALMOND  
0379986 ALMOND, BOXED

## HEAVY-DUTY TUBS\*

27" x 54" x 14-7/8" H (11-3/8" Depth)

### WHITE

0379970 LH WHITE  
0379627 LH WHITE, BOXED  
0379971 RH WHITE  
0379628 RH WHITE, BOXED

### ALMOND

0379972 LH ALMOND  
0379629 LH ALMOND, BOXED  
0379973 RH ALMOND  
0379630 RH ALMOND, BOXED

## PERMALUX PLUS

27" x 54" 15 7/16"H

### WHITE

0379967 LH WHITE, BOXED  
0379966 RH WHITE, BOXED  
0379965 MATCHING PERMALUX PLUS SURROUND

## HEAVY-DUTY TUBS WITH CENTER DRAIN\*

27" x 54" x 14-7/8" H (11-3/8" Depth)

### WHITE

0379885 WHITE

### ALMOND

0379886 ALMOND, BOXED

\*5 Yr. Warranty on Heavy Duty Tubs



## STANDARD GARDEN TUB

With Outside Step:

40" x 60" x 17-1/16" H (13-5/8" Depth)

### WHITE

0379993 WHITE, BOXED

### ALMOND

0379994 ALMOND



## HEAVY DUTY GARDEN TUBS WITH OUTSIDE STEP

40" x 54" x 17-1/16"H (12-3/8" Depth)

**WHITE**

0379975 WHITE  
0379632 WHITE; BOXED

**ALMOND**

0379974 ALMOND  
0379631 ALMOND; BOXED

46" x 60" x 21"H (15-1/2" Depth)

**WHITE**

0379982 WHITE  
0379624 WHITE; BOXED

**ALMOND**

0379983 ALMOND  
0379623 ALMOND; BOXED



40" x 60" x 17-1/16"H  
(13-5/8" Depth)

**WHITE**

0379969 WHITE  
0379626 WHITE; BOXED

**ALMOND**

0379968 ALMOND  
0379625 ALMOND; BOXED



## GARDEN W/CENTER DRAIN

42" x 60" x 19" (13-5/8" deep) without step

**WHITE**

0379995 WHITE

**ALMOND**

0379996 ALMOND



## BATH-SIZE SHOWER PAN & DOOR

Replace any 27" x 54" tub with this new shower pan. Fits in the same space with no plumbing change.

**WHITE**

0379096 WHITE RH  
0379095 WHITE LH

**ALMOND**

0379098 ALMOND RH  
0379097 ALMOND LH



## CORNER TUB

54" x 54" RH drain; 17.5" deep

**WHITE**

0379880 WHITE TUB  
0379881 WHITE SURROUND



## SHOWER PAN

Beveled inside perimeter lets water from the walls flow back into pan. New design also adds strength. 32" x 32".

**WHITE**

0379091 WHITE

**ALMOND**

0379090 ALMOND

## ABS TUBS/SURROUNDS

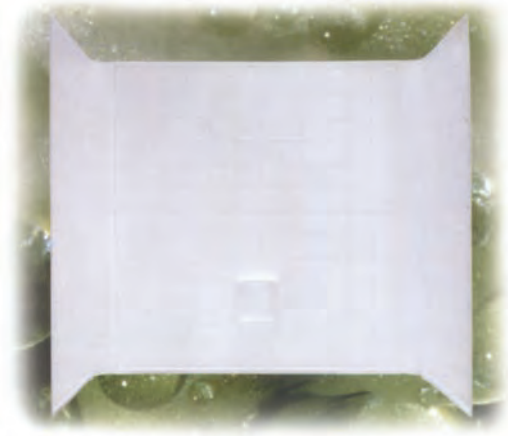

### One-Piece Tub Surround

Made of durable ABS with a built-in soap dish. Comes trifolded in individual boxes. Easy to install with adhesive or rivets (not included). Tile look unless otherwise noted.

#### WHITE

- 0379036 WHITE FOR 27" X 54" STANDARD TUB
- 0379103 WHITE SMOOTH FINISH FOR 27" X 54"
- 0379038 WHITE FOR 40" X 54" GARDEN TUB
- 0379029 WHITE FOR 40" X 60" GARDEN TUB

#### ALMOND

- 0379035 ALMOND FOR 27" X 54" STANDARD TUB
- 0379104 ALMOND SMOOTH FINISH FOR 27" X 54"
- 0379037 ALMOND FOR 40" X 54" GARDEN TUB
- 0379031 ALMOND FOR 40" X 60" GARDEN TUB

### Three-Piece Tub Surround

Made of durable ABS plastic, the interlocking panels support ease of installation. Easy to install with approved construction adhesive (not included).

#### WHITE

- 0379026 WHITE F/27" X 54" STD. TUB, SIDES & BACK
- 0379108 WHITE FOR 40" X 54" GARDEN TUB
- 0379110 WHITE FOR 40" X 60" GARDEN TUB

#### ALMOND

- 0379105 ALMOND FOR 27" X 54" STANDARD TUB
- 0379107 ALMOND FOR 40" X 54" GARDEN TUB
- 0379109 ALMOND FOR 40" X 60" GARDEN TUB

## RIVETS

#### WHITE

- 0379034 WHITE

#### ALMOND

- 0379033 ALMOND

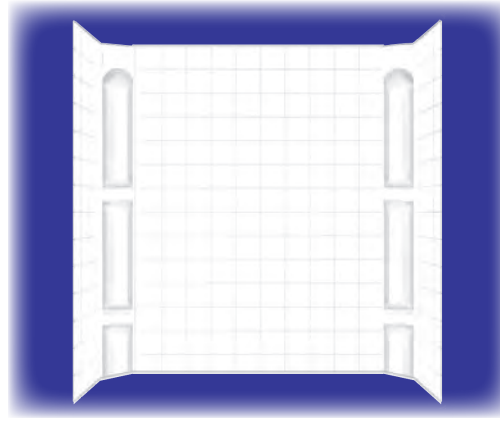

### Multi-Piece Surround with Corner Caddies

Calf-grain finish and tile look. All ABS stock formed from .080 sheet. Flanged lip at top and two sides for easier installation and straight wall finish. 57-3/4" high. One-year warranty.

#### WHITE

- 0379041 WHITE FOR 40" X 54" GARDEN TUB, SIDES & BACK
- 0379106 WHITE FOR 27" X 54" STANDARD TUB
- 0379042 4" X 3" WHITE CORNER CADDIES\*, 2 PK.

#### ALMOND

- 0379040 ALMOND F/40" X 54" GARDEN TUB, SIDES & BACK
- 0379025 ALMOND F/27" X 54" STD. TUB, SIDES & BACK
- 0379043 4" X 3" ALMOND CORNER CADDIES\*, 2 PK.

\*Please note that by adding the corner caddies to a 40" x 54" tub, for example, the surround now fits as 48" x 60" tub.

## SHOWER SURROUNDS FOR TUB OR SHOWER SIZES

Made of durable ABS with a built-in soap dish. Comes in individual boxes. Easy to install with adhesive or rivets (not included). Shower surround is 68" high and shower pan surround is 65.5" high.



#### WHITE

- 0379093 1-PC. WHITE FOR 32" X 32" SHOWER
- 0379099 3-PC. WHITE FOR 54" X 28" SHOWER PAN

#### ALMOND

- 0379092 1-PC. ALMOND FOR 32" X 32" SHOWER
- 0379100 3-PC. ALMOND FOR 54" X 28" SHOWER PAN



## COASTLINE TUB AND SHOWER SLIDING DOORS

The modern, sleek styling of this series of bath enclosures is enhanced by a cleaner, smoother, more stylish towel bar.

- Standard Aquatex Obscure GLass
- Out of plumb panel adjustment
- Complete wrap-around vinyl glazing
- Easy to install
- Stay clean track with snap-in guide
- Nylon ball bearing adjustable rollers
- Jamb alignment guide
- Silver Satin Finish

0378208 FOR TUB 52"W X 55-7/8"H

0378201 FOR TUB 54"W X 56-7/8"H

0378213 FOR SHOWER PAN 52" W X 68-7/8"H (FITS NEW BAYMONT SHOWER PANS)

0378209 FOR SHOWER PAN 50"W X 64-7/8"H (FITS MAAX SHRW PANS)

0378207 FOR SHOWER PAN 52"W X 62"H

0378206 FOR SHOWER PAN 54" W X 64-7/8"H

0378210 REPLACEMENT ROLLERS

0378303 54" REPLACEMENT SILL TRACK



## TRIDENT PIVOT SHOWER DOORS

Cut installation time to the absolute minimum.

- Adjustable strike jamb for out of plumb
- 1-1/2" width adjustment
- Full-length built-in handle
- Full threshold and full length magnetic latch
- Built-in drip cap
- Silver Satin finish

0378202 FOR SHOWER 24-1/2"-26-1/4"W X 64-1/2"H

0378205 FOR SHOWER 26-1/2-28-1/4"W X 64-1/2"H

0378204 FOR SHOWER 31-1/2-33-1/4"W X 64-1/2" H

0378203 FOR SHOWER 27-1/4-29-3/4"W X 68-1/2"H

0378306 CHROME SILL KIT, INCLUDES 36" DRIP RAIL, 36" VINYL SWEEP, DRIP CAP PLUGS AND 2-SIDED TAPE

0378304 3/4" X 3' BLACK RUBBER SEAL

0378305 1-1/8" BLACK RUBBER SEAL

## FLANGE LOCKS

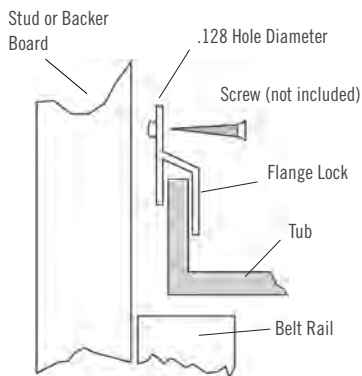

Holds tub or shower pans against wall while allowing environmental expansion and contractions without cracking the tub or shower pan. Stainless steel to prevent rusting or discoloration while providing a strong "spring" action.

0379039

## MIRRORED COVER-UPS

Acrylic cover-up installs on all standard bath/shower fittings with silicone caulk.



0375891 3 HANDLE

## TRIM KITS



Kits include: one 60" retainer, three 48" retainers, one 60" molding, four 48" moldings, 2 inside corners and 2 outside corners.

0265530 60" WHITE KIT  
0265529 60" ALMOND KIT

Kits for 54" include: two 54" retainers, two 54" moldings, 2 inside corners and 2 outside corners.

0265531 54" WHITE KIT  
0265532 54" ALMOND KIT



## BATH/TUB REPAIR KIT

Comes with everything for the most demanding repairs to all types of plastics, fiberglass and even enamel bath fixtures. Shower stall cracks can be repaired in minutes.



0110235

## PLASTIC TUB MOLDING

0265525 TUB, 8' ALMOND 1-5/8" W X 8' L  
0265526 TUB, 8' WHITE 1-5/8" W X 8' L  
0265527 INSIDE CORNER, 8' ALMOND  
0265528 INSIDE CORNER, 8' WHITE



## CONCAVE COVE

Two 6' 3/4" cove lengths of polished aluminum. 10/Ctn.

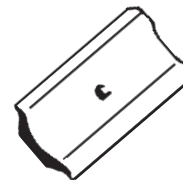

0265520

## TUB MOLDING

54" set includes; 2-28" and 1-53-1/2" length coves, one each of right and left hand ends, and 2 corners. Bagged. 6/Ctn.

0265515

## GARDEN TUB MOLDING

Garden Tub Set: 60" set includes 2-48-5/8" and 1-59-1/4" and 2-23-5/8" length coves. Ends and corners.

0379919 30/CTN.  
0265518 SCREWS; 50/BOX

## METAL STRAINER



Metal 4-1/4" flat sink strainer less locknut with grid, large rubber washer and metal washer.

0374115 50/CTN.

## RUBBER STOPPERS



0379003 1-3/4" ; 72/CTN.

## TUB BASKET

2" stainless steel strainer with rubber stopper.



0374105 100/CTN.

## TOE-TOUCH DRAIN

1-1/2" C.P. toe-touch drain, brass.



0374110

## 1-1/2" TUB TRAP SWIVEL

0320794



## SHOWER DRAIN



1 -1/2" Shower Drain with Stainless Steel Grid and Locknut. Chrome.

0374117

## BATHTUB DRAIN

Chrome 1-1/2" pop-stop drain with positive push-pull seal. Stopper seats and seals with a finger-tip touch. Plug is completely removable for cleaning. Comes with locknut.



0374107 50/CTN.

0374109 GASKET FOR 0374107

## BATHTUB DRAIN PACK



Complete with chrome pop-stop tub drain, ABS P-trap and swivel strainer adapter. 1-1/2".

0321614

## TRAP ADAPTER with Washer & Nut

1-1/2" x 1-1/2" or 1-1/2" x 1-1/4" furnished with both size SJ washers.

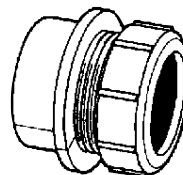

0321613 25/CTN.

## FLIP-IT FIT-ALL BATHTUB STOPPER

Fits 90% of all tub drain openings! Needs no tools to install!



Just press into drain and it stays there.....

Contains a unique ball-shift toggle system which opens and closes the drain with a simple push of the toe or finger. Fits all 1-3/8" to 1-5/8" tub drains. To install, just affix the included "O" ring and press into drain. Complete with "O" rings and instructions. Chrome in clamshell pack.



0374120

## REPLACEMENT CHROME TUB STOPPER

Polybag with hang hole.



0374123

## TUB TRAP ADAPTER

1-1/2" sp x NPSM. 0321615 50/CTN.

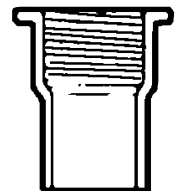

## READY TO GO TOILET

- Round Front
- Size:26"(L) x 15.75"(W) x 29"(H)
- Two-piece Toilet
- Single left side flush:1.6 gallon
- Diameter of Outlet: 2.25"
- Includes: Wax Ring ,Bolts
- Seat cover and Fittings



### WHITE

0370217 WHITE TOILET

0370192 REPLACEMENT BOWL,  
WHITE

0370193 REPLACEMENT TANK,  
WHITE

### BISCUIT

0370218 BISCUIT TOILET

0370190 REPLACEMENT BOWL,  
BISCUIT

0370191 REPLACEMENT TANK,  
BISCUIT

## READY TO GO TOILET HANDICAPPED BOWL

- Two-piece Toilet, 29"(L) x 17"(W) x 30"(H)
- Single left side flush:1.6 gallon
- Diameter of Outlet: 3"
- Includes: Wax Ring,Bolts, Seat cover and Fittings.



### WHITE

0370213 WHITE TOILET

0370211 REPLACEMENT BOWL, WHITE

0370193 REPLACEMENT TANK, WHITE



## TOILET SEATS

Economical, light-weight polypropylene.

0371201 ROUND WHITE; 6/CTN.

0371204 ROUND ALMOND; 6/CTN.

0371205 ELONGATED WHITE; 6/CTN.

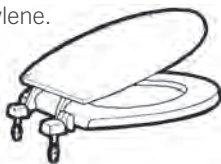

## PLASTIC CLOSET RINGS

0320901 MALE 3"; 50/CTN.

0320902 FEMALE 3"; 50/CTN.

0320903 3" X 4" W/TEST CAP



## REAR CLOSET BOLT SET

Two each 1/4 -20 x 1-3/4" brass plated steel bolts, open head nuts, retaining clips and oval washers. 10/Ctn.

0372902



## TANK TO BOWL

Bolt set includes 2 each solid brass 5/16-18 x 3" bolts, 4 plated steel washers, 2 hex nuts, 2 wing nuts & 4 rubber washers. 72/Ctn.

0372901 BOLT SET

0379501 RUBBER TANK TO BOWL GASKET

0379502 TANK TO BOWL GASKET FOR GERBER & CRANE



## TOILET TANK LEVER

Front Mount. C.P. single action tank lever.



0373201 200/CTN.

## WAX BOWL RING

Permanent leak proof seal. Fits 3" x 4" waste lines. For all floor type closet bowls.

0321301 48/CTN.

0321302 W/SLEEVE; 24/CTN.

Meets Military Spec. TT-P-1536A



## WAX-FREE TOILET SEAL

3" toilet flange installed on 3" drain pipe.

- Seals on floors raised above the flange by up to 3/4"
- Impervious to mold and mildew
- Centers itself and the toilet to the drain

0321305 20/CTN.



## TOILET SEAT LOCK

Install or remove in minutes; no special tools needed.

Not connected to commode, so it will not mar or scratch. Reusable. 24/Ctn.

0371004 FOR WATER-SAVER 1.6 GAL.

0371005 FOR ELONGATED BOWL







The Most Popular Name in Plumbing Repair. Superior engineering and top-grade materials add up to years and years of trouble-free toilets. We are always searching and finding new ways to make our repair products work better and last longer. All products are in bright, retail boxes for easy recognition on the store shelf!

## COMPLETE TOILET TANK REPAIR KIT 400AK

- Contains a flush valve with an adjustable water saving flapper, a fill valve, a chrome tank lever and the bolts and gaskets for installation.
- Chrome tank level trims/bends to fit, no pre-measuring needed
- Flapper dials to adjust water volume for a custom flush
- Fits more 2-piece toilets with a 2" flush valve opening



0370104 400AK

## 400-A TOILET TANK REPAIR VALVE

400A- #1 Selling fill valve in the world. Anti-siphon. Height adjustable 9" to 14". Code approved. 1 year warranty.



0370100 25/CTN  
0370101 3-PK

## TOILET FILL VALVE REPAIR KIT

Includes chemical-resistant flapper, 3/8" compression x 7/8" fill valve and a 12" water supply connector.



0370107 400AWF

## VALUE PACK KIT

Contains the most popular flapper (#504) and flush valve (#400A) in one convenient package.



0370105 400AW504

## 2" TOILET FLUSH VALVE AND FLAPPER

Repairs leaks between tank and bowl.

0370901 7/CTN



## TOILET FLAPPER 500

Easy to install, universal fit, works on most toilets. Rigid frame seals the drain every time. Fits plastic or metal flush valves with or without mounting ears. 1 year warranty.



0370902 FLAPPER 21/CTN

## TOILET FLAPPER 504

Universal fit. Chlorine-resistant materials. Works on most toilets. Easy to install. Kink-free chain. Also replaces American Standard actuator units. Fits plastic or metal flush valves with or without mounting ears. 5 Year warranty.



0370106 FLAPPER 20/CTN

## ACCESS PANEL



Quick, easy access to plumbing, electrical, telephone, sprinklers, etc. and lowers the cost of future repairs. Easy to install: just measure, cut, then pop in the panel.

Patented, spring-loaded mechanism permits frameless mounting from the outside. High-impact, non-yellowing polystyrene panel is backed by one-year warranty. No screws, latches, fasteners or framework needed. Lightly textured surface accepts wallpaper or paint.

0370332 8" X 8" PANEL  
0370333 14" X 14" PANEL



## MEDICINE CABINET



Fits 2-1/2" recess; installs with 4 screws. Three shelves. Magnetic closure.

Rough opening:  
13-1/8"W x 17-1/8"H x 2-3/8"D

Overall dimensions  
16-1/8"W x 20-1/4"H.

0378121 4/CTN.

## FLOWTITE™

The only stop valve that is code approved to be installed on Copper, CPVC, or PEX pipe and backed by a written 10 year labor and material Warranty One FlowTite Valve Fits all. 12"



0374426 12" X 7/8" BALLCOCK NUT

## WATER SUPPLY LINE



**TOILET**  
3/8" x 12" Ballcock  
0374466

## TISSUE HOLDER

Zinc Chrome metal, springloaded, concealed screw mounting. Screws included. 12/Ctn.

0370320



## SHOWER CURTAIN RINGS

12 Zinc Plated Rings. Steel construction. No tools needed for installation.

0377227 12/CARD.



## CURTAIN RINGS

Stainless steel with ball bearings

0377233 12/PK



## QEST SUPPLY TUBES

100/Ctn.

3/8"OD x 20"L Closet

0374420

Ballcock 5/8" Nut

0374421

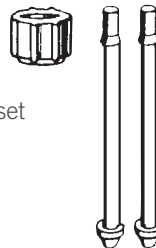

## LOW FLOW SHOWER HEAD



9-Jet Turbo Massage. Consistent flow rate regardless of water pressure.



0378850 1.5 GAL.

0378851 2 GAL.

## ADJUSTABLE SHOWER ROD W/ FLANGES

Chrome

0377222

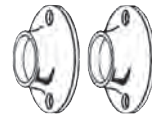

## ADJUSTABLE CURVED SHOWER ROD

Length adjusts to 3', 4', 5' or 6'. Stainless steel, includes wall brackets and swivel arms.

0377231

## CURVED SHOWER ROD W/FLANGES



Adjustable, 58-in to 61-in, stainless steel oval rod uses standard curtain.

0377220

## TOILET TANK BANK

Displaces water in the toilet tank, reducing amount of water used.

Fill to top, snap to close and hang in toilet.

Non-corrosive materials that resist fungal growth. 4,380 gallons saved yearly.



0370108

## CHINA LAVATORY SINK

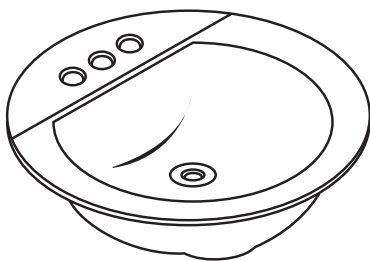

17" x 20" oval porcelain drop-in bowl.

**WHITE**                      **BONE**  
0376815 WHITE              0376816 BONE

## PLASTIC LAVATORY SINK

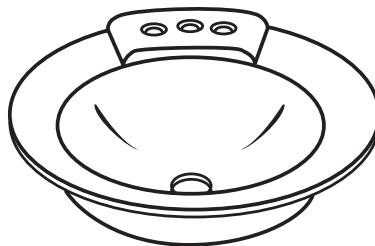

17" x 20" oval polypropylene, less overflow.

**WHITE**                      **BONE**  
0376805 WHITE; 8/CTN.    0376807 BONE; 8/CTN.

### CO Plug & Drain

Matching CO plug & drain

**WHITE**                      **BONE**  
0377202 WHITE              0377200 BONE

## RECTANGULAR LAVATORY

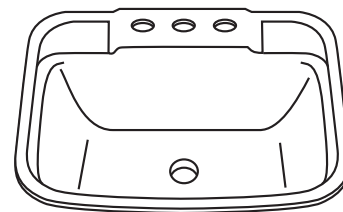

Rectangular lavatory sink, plastic. 17" x 20"

**WHITE**                      **BONE**  
0376804 WHITE              0376803 BONE

## STAINLESS STEEL KITCHEN SINK W/FAUCET LEDGE

Nickel-bearing stainless steel bowls are buffed and complemented by a satin-buffed top deck. Sound deadening material is applied to the bowl base. 4 holes in faucet ledge.

0373601 33" X 19" OD; 13" X 14" BOWL; 6" D  
0373603 33" X 19" OD; 8" D  
0373606 33" X 19" OD; 7" D  
0373610 33 X 19"OD X 8"D UNBOXED, 50/CTN.



## WHITE PERMALUX KITCHEN SINK

Double bowls in "Permalux Plus" finish: acrylic sink with two-part polyurethane added to the back for added strength. Higher and deeper gloss than fiberglass with permanent gloss retention. Caulked finish looks like one-piece unit. Durable and stain resistant, will not chip, peel or spiderweb. UV protection. Resists scratching and marring. Cleaner/chemical resistant. Four fixture mounting holes. Five-year warranty.

0373602 19" X 33" X 7-1/2" WHITE PERMALUX KITCHEN SINK  
0373611 17" X 20" X 6"D  
0374100 BASKET W/STRAINER, WHITE



## SINK CLIPS

Stainless steel, self-rimming U channel sink compression clip with screws.

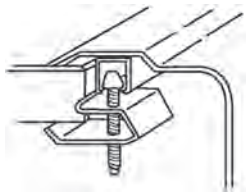

0373202 10 CT. PER BAG

## RISER WITH NUT

Supply Line



0374425 30" X 3/8"  
0374480 20" X 1/2" FIP

## FLOWTITE™ SINK SUPPLY



0374428 1/2" IPS NUT

## SINK SUPPLY LINES

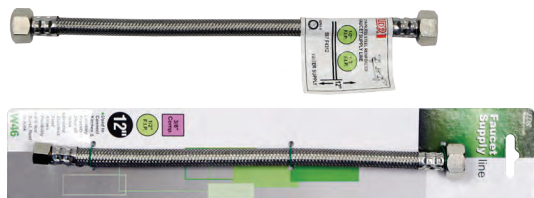

0374417 1/2" X 3/8" COMPRESSION 12"  
0374418 1/2" IPS 12"; 10/CTN.  
0374486 1/2" FIP X 1/2" FIP X 24" PVC  
0374487 1/2" FIP X 1/2" FIP X 48" PVC

## ADAPTER DRAIN & TRAP CONNECTOR

Installs quickly and easily without special tools, gluing, threading or soldering. Simply place the ends over the pipes and tighten the rust-proof clamps. Connects 1-1/4" or 1-1/2" tubular traps to all common 1-1/4" or 1-1/2" drain piping.



0321895 20/CTN.

## SINK HOLE COVERS

1-3/4" hole covers for stainless steel.



0373600

## CO PLUG & DRAIN

Plastic Stopper f/1-Piece



0377203 CHROME  
0377202 WHITE  
0377200 ALMOND  
0377205 REPL. GASKET

## CO PLUG

1-1/4" x 5" CO plug w/chain and rubber stopper. 25/Ctn.



0377201 CHROME

## CHROME ABS POP-UP

Use with china lavatories 0376815 & 0376816.



0377204 CARDED

## REPLACEMENT STOPPERS



0374122 CHROME  
0374108 IVORY

## "P" TRAP ADAPTER

Male with washer and nut. 1-1/2"  
SP X SJ. 300/Ctn.

0321606

0375004 BEVELLED WASHER ONLY



## PVC-DWV "P" TRAP



0321479 SCH 40

## "P" TRAP

1-1/2" P-trap, black  
polypropylene. 25/Ctn.

0375203



## "P" TRAP W/UNION

ABS 1-1/2" H x H,  
without CO.

0321607 35/CTN.



## BEVELLED WASHER

1.5" rubber bevelled washer for  
use with P-trap adapter 321606.

0375004



## PLUMBING VENT

Automatic 1-1/2" vent  
with adapter.

0425205 50/CTN.



## REDUCING ELBOW

Plastic, 3/4" x 3/4" combination and  
reducing elbow. Insert x MPT.

0321541

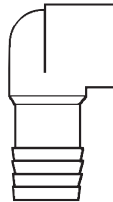

## FLAT WASHER

1.5" rubber.

0375003 50/CTN.

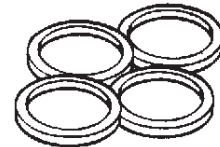

## Flexible Fittings

### COUPLERS

- Elastomeric PVC, not rubber
- High tear and shear strength
- Highly resistant to caustic chemicals and ozone
- Rust-proof Series 300 stainless steel bands including screw and housing to assure easy installation and a positive seal.



0321893 1-1/2"

0321890 3"; 10/CTN.

0321892 2"; 10/CTN.

0321891 4"; 10/CTN.

### QWIK ELBOW

Connects all common household drain, waste & vent  
pipes quickly without special tools or fittings.

Flexible, x-long, ideal for fittings cut out at the  
joint during alteration or repair.

Flexible PVC 3" x 3".

0321897



### REDUCING COUPLER

0321894 3" TO 4"; 10/CTN.



## DISHWASHER DRAIN AIR GAP

Eliminates pressure build-up and possible contamination of water. Durable plastic with intake and discharge tube and a trouble-free air release valve for automatic anti-siphon protection. 5/8" OD inlet x 7/8" OD outlet.



0375006 DISHWASHER DRAIN AIR GAP

## PVC BASKET & STRAINER

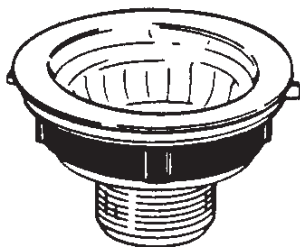

Plastic 3", with stainless steel ring.

0374101 BASKET & STRAINER 48/CTN.

0374202 WASHER; 50/CTN.

0374106 BASKET ONLY

## WHITE PLASTIC BASKET & STRAINER



0374100 WHITE

## ADJ. CONTINUOUS WASTE



0375001 1-1/2"; 50/CTN.

0375003 WASHER

## ADJ. CONTINUOUS WASTE W/TAILPIECE



0375005 1-1/2"; 15/CTN.

0375003 WASHER

## METAL BASKET & STRAINER

Stainless steel sink strainer to fit sinks with openings.

0374104 BASKET & STRAINER; 50/CTN.

0374103 REPL. BASKET F/374104

0374202 WASHER; 50/CTN.







American Brass offers faucet models with compression, washerless and ceramic disc cartridges. Equipped with metal housings our two handle and single handle designs feature acrylic handles and metal handles. Metal teapot lever handles for our dual handle models and metal single blade styles for our single handle models. Tub & Shower models can be ordered with or without our Anti-Scald feature.

This line of faucets can be found in residential environments ranging from single family and multi-family housing structures to apartment and hotel projects. A long history of building, testing and supplying faucets with a deliberate goal of providing a quality product with a strong reputation for reliability has proven successful for nearly 120 years.

## ECONOMY LINE: KITCHEN, LAVATORY & SHOWER

6/Carton - Chrome

### Two-Handle Kitchen with D-Spout & Crystal Handles



0374381 J801F W/SPRAY  
0374380 J800F W/O SPRAY

### Single-Lever Lavatory with Crystal Handle



0377104 SL77  
0377103 SL77 - NON-METALLIC

### Two-Handle Lavatory with Jewelite Crystal Handles



0377101 J77

### Single-Lever Tub/Shower with Crystal Handle



SL68 SINGLE-LEVER TUB/SHOWER WITH CRYSTAL HANDLE  
SL59 SINGLE-LEVER SHOWER ONLY WITH CRYSTAL HANDLE

## KITCHEN SERIES: PULL DOWN & PULL-OUT MODELS

6/Carton

### Single-Lever Gooseneck Pull-down with Spray & Optional Deck Plate



SL2000 CHROME  
SL2000N BRUSHED NICKEL  
SL2000ORB OIL-RUBBED BRONZE

### 8" Single-Lever Pull-out Spout with Spray & Deck Plate



0374616 SL1000 CHROME  
0374615 SL1000N BRUSHED NICKEL  
SL1000ORB OIL-RUBBED BRONZE

## KITCHEN SERIES: SINGLE & TWO HANDLE

6/Carton

### 8" Single-Lever D-spout & Matching Spray for 4-H Sink



0378821 SL801F-4 CHROME  
0374624 SL801FN-4 BRUSHED NICKEL  
SL801FORB-4 OIL-RUBBED BRONZE

For three hole sink without spray  
0378813 SL800F CHROME

### 8" Single-Lever D-spout & Matching Spray On-Deck for 3-H Sink



0374611 SL801F-3 CHROME  
0374612 SL801FN-3 BRUSHED NICKEL  
SL801FORB-3 OIL-RUBBED BRONZE

### 8" Kitchen with Teapot Handles, Gooseneck Spout & Matching Spray



0374609 CH801GS CHROME  
0374610 NN801GSN BRUSHED NICKEL  
OB801GSORB OIL-RUBBED BRONZE

## KITCHEN SERIES: SINGLE HANDLE

6/Carton

### Single-Lever Gooseneck Spout with Spray



0374627 SL801GS CHROME  
0374628 SL801GSN BRUSHED NICKEL  
SL801GSORB OIL-RUBBED BRONZE

### Single-Lever with Gooseneck Spout with Spray & Soap Dispenser



0374625 SL801GSWSD CHROME  
0374626 SL801GSNWSD BRUSHED NICKEL  
SL801GSORBWSD OIL-RUBBED BRONZE

## LAVATORY SERIES: SINGLE & TWO HANDLE

6/Carton

### 4" Single-Lever with Blade Handle



0374607 SL77LVR CHROME  
0374608 SL77NLVR BRUSHED NICKEL  
0374645 SL77ORB LVR OIL-RUBBED BRONZE

### 4" with Teapot Handles & Arc Spout



0374605 CH77-ARC CHROME  
0374606 NN77N-AR BRUSHED NICKEL  
OB77ORB-ARC OIL-RUBBED BRONZE



## LAVATORY SERIES: TWO HANDLE – 4” & ADJUSTABLE CENTERS

6/Carton

**4” Tall Old World Spout with Lever Handles & Drain**



0374635 NN99N BRUSHED NICKEL  
0374636 OB99ORB OIL-RUBBED BRONZE

**4” High-arc Spout & Lever Handles with Pop-up Drain**



0374620 CH88 CHROME  
0374621 NN88N BRUSHED NICKEL

**Widespread with Arc Spout & Teapot Handles**



0374622 CH29LAS CHROME - LOW SPOUT  
0374637 CH29LAS CHROME - HIGH SPOUT  
0374623 NN29NLAS BRUSHED NICKEL  
ORB29ORB-LAS OIL-RUBBED BRONZE

## TUB & SHOWER SERIES: STANDARD & ANTI-SCALD

6/Carton

**Single-Lever Diverter Spout with Blade Handle**



**STANDARD**

0374638 SL68LVR CHROME  
0374639 SL68NLVR BRUSHED NICKEL  
SL68ORB LVR OIL-RUBBED BRONZE

**ANTI-SCALD**

SL68ASLVR CHROME  
SL68NASLVR BRUSHED NICKEL  
SL68ASORBLVR OIL-RUBBED BRONZE

## SHOWER SERIES: STANDARD & ANTI-SCALD

6/Carton

**Single-Lever Shower Only with Blade Handle**



**STANDARD**

0374640 SL59LVR CHROME  
0374641 SL59NLVR BRUSHED NICKEL  
SL59ORB LVR OIL-RUBBED BRONZE

**ANTI-SCALD**

SL59ASLVR CHROME  
SL59NASLVR BRUSHED NICKEL  
SL59ASORBLVR OIL-RUBBED BRONZE

## ADJUSTABLE BATH TUB FILLERS

6/Carton

**Adjustable Garden Tub Filler with High-arc Spout & Teapot Handles**



0374637 CH29HAS CHROME  
NN29NHAS BRUSHED NICKEL  
ORB29ORB-HAS OIL-RUBBED BRONZE

## BAR FAUCETS

6/Carton

**4” Bar High-arc Spout with Teapot Handles**



0377100 CH16 CHROME  
NN16N BRUSHED NICKEL  
OB16ORB OIL-RUBBED BRONZE

## SOAP DISPENSERS

6/Carton

SPDSPNSR-CHRM	CHROME
SPDSPNSR-BN	BRUSHED NICKEL
SPDSPNSR-ORB	OIL-RUBBED BRONZE



## RAINFALL SHOWER KIT WITH ARM & FLANGE

6/Carton



0374631	RNFL-SHWRKT-CP	CHROME
0374632	RNFL-SHWRKT-BN	BRUSHED NICKEL
0374630	RNFL-SHWRKT-ORB	OIL-RUBBED BRONZE

## ALL-METAL LAVATORY DRAIN WITH OVERFLOW

50/Carton



S350	CHROME
350N	BRUSHED NICKEL
350ORB	OIL-RUBBED BRONZE

## AMERICAN BRASS MARKETING MATERIALS

American Brass marketing materials are available for promotional purposes to support your sales and marketing efforts. Eye-catching packaging coordinates with colorful displays, banners and headers, providing visual merchandising which builds strong customer relationships. Product, price, promotion and value will enhance your marketing strategy and position you for increased sales.



- 0374597 AMERICAN BRASS BANNER, 24" H X 36" W
- 0374598 AMERICAN BRASS HEADER BOARD
- 0374599 AMERICAN BRASS LAVATORY & KITCHEN FAUCET DISPLAY, FAUCETS NOT INCLUDED.



Designed specifically to meet the specialized needs of the manufactured housing industry, Empire features both brass and non-metallic faucets. Lightweight faucet models made of thermoplastic materials meet weight and price points required of the manufacturers. Available in finishes that compliment lighting and hardware accessories.

Choices available for new units, as well as hard to find pieces used years ago in previously built units. Designs available for thin wall applications often

seen in factory built homes. Hi-arc garden spouts designed to clear rolled edges and sloped walls of garden tubs commonly seen in manufactured homes today.

Empire is your choice when repairing or replacing your manufactured home or recreational vehicle.

## ECONOMY (PLASTIC) FAUCET LINE

### 8" Kitchen w/ Crystal Handles & D-spout

24 bulk



0378004 U-YJW800F CHROME

### 4" Lav w/ Crystal Handles

24 bulk



0378001 U-YJW77 CHROME

### U-YJW68L 8" Tub/Shower Diverter w/ Crystal Handles, less Shower Kit (Inline Shanks)

12 bulk



0378805 U-YJW68 CHROME

0374433 U-YJW68L CHROME - LESS SHOWER KIT (INLINE SHANKS)

### 8" Tub/Shower Diverter w/ Crystal Handles

12 bulk



0377136 U-YJW68-OFS CHROME - W/SHOWER KIT (OFFSET SHANKS)

0377135 U-YJW68L-OFS CHROME - LESS SHOWER KIT (OFFSET SHANKS)

### 8" Shower Only w/ Crystal Handles

24 bulk



0377112 U-YJW59 CHROME

0377111 U-YJW59L CHROME - LESS SHOWER KIT

### 4" Shower Only w/ Crystal Handles

24 bulk



0374401 U-YJW54 CHROME

0377109 U-YJW54L CHROME - LESS SHOWER KIT

### Adjustable Garden Tub Filler w/ Crystal Handles & Hi-arc Spout

20 bulk



0374429 U-YJW29 CHROME



## ULTRA LINE 8" KITCHEN DESIGNER (PLASTIC) FAUCETS

### 8" Kitchen w/ Teapot Handles w/ Hi-rise Spout

24 bulk



0377150	U-YCH800RS	CHROME
0377152	U-YWI800RSW	WHITE - W/ HI-RISE SPOUT
	U-YBB800RSB	BISCUIT - W/ HI-RISE SPOUT
0377151	U-YNN800RSN	NICKEL - W/ HI-RISE SPOUT
0377153	U-YAB800RSAB	ANTIQUE BRASS - W/ HI-RISE SPOUT

### 8" Kitchen w/ Teapot Handles w/ Gooseneck Spout

12 bulk



U-YCH800GS	CHROME
U-YCH801GSL	CHROME - W/SPRAY
U-YNN800GSN	NICKEL
U--YOB800GSOB	OIL RUB BRONZE
U-YOB801GSOB	OIL RUB BRONZE - W/SPRAY

### 8" Kitchen w/ Teapot Handles w/ D-spout

24 bulk



U-YNN800FN	NICKEL
U-YOB800FOB	OIL RUB BRONZE

### 8" Non-metallic Kitchen Faucet w/ Pull-Down Vegetable Sprayer & Teapot Handles

24 bulk



U-YNN2000N	BRUSHED NICKEL
U-YOB2000OB	OIL RUB BRONZE

## ULTRA LINE 8" TUB/SHOWER DIVERTER DESIGNER (PLASTIC) FAUCETS

### 8" Tub/Shower Diverter w/ Teapot Handles & Shower Kit

U-YCH68	CHROME
U-YNN68N	NICKEL
U-YOB68OB	OIL RUB BRONZE





## ULTRA LINE 4" LAVATORY DESIGNER (PLASTIC) FAUCETS

### 4" Lav w/ Teapot Handles

24 bulk



0377155	U-YCH77	CHROME	U-YBB77B	BISCUIT
0377156	U-YNN77N	NICKEL	U-YOB770B	OIL RUB BRONZE
0377157	U-YWI77W	WHITE		
0377158	U-YAB77AB	ANTIQUE BRASS		

### 4" Lav w/ Teapot Handles & Arc Spout

24 bulk



U-YCH77-ARC	CHROME
U-YNN77N-ARC	NICKEL
U-YOB770B-ARC	OIL RUB BRONZE

### 4" Lav w/ Cross Handles & Arc Spout

24 bulk



U-YCH77-ARC-CRS	CHROME
U-YNN77N-ARC-CRS	NICKEL
U-YOB770B-ARC-CRS	OIL RUB BRONZE

### 4" Lav w/ Teapot Handles & Old World Spout

24 bulk



U-YCH77-OWS	CHROME
U-YNN77N-OWS	NICKEL
U-YOB770B-OWS	OIL RUB BRONZE

### 4" Lav w/ Smoke Crystal Handles

24 bulk



U-YCJW77N	NICKEL
U-YJW77W	WHITE
X-YCJW77B	BISCUIT

## ULTRA LINE 4" TUB/SHOWER DIVERTER DESIGNER (PLASTIC) FAUCETS

### 4" Tub/Shower Diverter w/ Crystal Handles w/ Vacuum Breaker



U-YJW41VB	CHROME
U-YJW41VBW	WHITE
U-YCJW41VBB	BISCUIT
U-YCJW41VBN	NICKEL
U--YCJW41VBAB	ANTIQUE BRASS

### 4" Tub/Shower Diverter w/ Teapot Handles w/ Vacuum Breaker



U-YWI41VBW	WHITE
U-YNN41VBN	NICKEL
X-YOB41VB0B	OIL RUB BRONZE

## ULTRA LINE 8" SHOWER VALVE DESIGNER (PLASTIC) FAUCETS

### 8" Shower Valve w/ Teapot Handles & Shower Kit

24 bulk/ctn

0371554 U-YCH59 CHROME  
U-YNN59N NICKEL  
U-YOB590B OIL RUB BRONZE



## ULTRA LINE 4" SHOWER VALVE DESIGNER (PLASTIC) FAUCETS

### 4" Shower Valve w/ Teapot Handles & Shower Kit

24 bulk/ctn

U-YNN54N NICKEL  
U-YOB540B OIL RUB BRONZE



### 4" Personal Shower Valve w/ Smoke Crystal Handles w/ Vacuum Breaker

24 bulk/ctn

0378606 U-YJW53VB CHROME U-YCJW53VBN NICKEL  
U-YJW53VBW WHITE U-YCJW53VBAB ANTIQUE BRASS  
U-YCJW53VBB BISCUIT



### 4" Personal Shower Valve w/ Teapot Handles w/ Vacuum Breaker

24 bulk/ctn

U-YWI53VBW WHITE  
X-YNN53VBN NICKEL  
X-YOB53VB0B OIL RUB BRONZE



## ULTRA LINE GARDEN TUB FILLER DESIGNER (PLASTIC) FAUCETS

### Adjustable Garden Tub Filler w/ Teapot Handles & Hi-arc Spout

20 bulk/ctn

U-YCH29 CHROME  
U-YNN29N NICKEL  
XU-YOB290B OIL RUB BRONZE



### Adjustable Garden Tub Filler w/ Teapot Handles & Low-arc Spout

20 bulk/ctn

U-YNN29NLRs NICKEL





## ULTRA LINE LAVATORY DIVERTER DESIGNER (PLASTIC) FAUCETS

24 bulk/ctn

### 4" Lav Diverter w/ Crystal Handles

U-YJW73	CHROME
U-YJW73W	WHITE
U-YCJW73B	BISCUIT
U-YCJW73N	NICKEL
U-YCJW73OB	OIL RUB BRONZE
U-YCJW73AB	ANTIQU BRASS



### 4" Lav Diverter w/ Teapot Handles

U-YW173W	WHITE
----------	-------



## ULTRA LINE BAR DESIGNER (PLASTIC) FAUCETS

24 bulk/ctn

### 4" Bar w/ Teapot Handles

U-YCH16	CHROME
U-YNN16N	NICKEL
U-YOB160B	OIL RUB BRONZE



## VALUE-ADDED (PLASTIC) FAUCETS WITH BRASS STEMS

12/ctn

### 8" 2-Handle Kitchen Value-Added w/ D-spout



0377106	YJ800F	CHROME
0374399	YJ801F	CHROME W/SPRAY

### 4" 2-Handle Lavatory Value-Added



0377105	YJ77	CHROME
---------	------	--------

### 8" 2-Handle Diverter Surface-Mount Value-Added w/ HAF

less Shower Kit (Not Shown)



0377816	YJ68	CHROME
0377107	YJ68L	CHROME, BAGGED
0377126	CJ68N	BRUSHED NICKEL

### 8" 2-Handle Tub Filler Surface-Mount Value-Added



YJ60	CHROME
------	--------

### 8" 2-Handle Tub Filler Deck-Mount Value-Added



YJ30	CHROME
------	--------

### 8" 2-Handle Shower Valve Surface-Mount Value-Added w/ HAF

less Shower Kit (Not Shown)



0375912	YJ59	CHROME
0377108	YJ59L	CHROME, BAGGED

## DURABLE (BRASS) FAUCETS WITH BRASS STEMS

12/ctn

**8" 2-Handle Wall-Mount  
In-Line Diverter w/ Brass  
Underbody & Brass Stems  
HAF**



0378815 J68 CHROME  
0375907 J68OFS CHROME OFFSET UNDERBODY  
(NOT SHOWN)  
0374433 U-YJW68L NON-METALLIC

**8" 3-Handle Concealed-  
In-Wall Positive Diverter  
One Piece Brass  
Underbody**



0378603 J2700R CHROME

**8" 2-Handle Concealed-  
In-Wall Automatic  
Diverter One Piece Brass  
Underbody**



0378811 J228AF CHROME

**4" 2-Handle Wall-Mount  
Diverter w/ Brass Underbody  
& Brass Stems w/ HAF**

Less HAF (Not Shown)



0378814 J50 CHROME  
J50L CHROME

**8" Concealed Shower  
Valve w/ Brass  
Underbody & Brass  
Cartridges w/ Shower Kit**



375902 J59 CHROME

**4" 2-Handle Wall-  
Mount Diverter w/ Brass  
Underbody  
& Brass Stems w/ Vac  
Breaker For Shower**



J51VB CHROME

**3 3/8" 2-Handle Diverter w/  
Brass Underbody & Brass  
Stems For Concealed Riser**



0378604 380 CHROME

**4" 2-Handle Wall-  
Mount Diverter w/ Brass  
Underbody & Brass  
Stems w/ Riser Adapter  
For Exposed Riser**



0378818 J51-0 CHROME

**3 3/8" 2-Handle  
Diverter w/ Brass  
Underbody & Brass  
Stems w/ Riser Adapter  
For Exposed Riser**



0378602 381 CHROME





## DURABLE (BRASS) FAUCETS WITH BRASS STEMS

12/ctn

**Adjustable Garden Tub Filler w/ Brass End Valves plus 8" 2-Handle Deck-Mount Tub Filler**



0374412 J29 CHROME  
J28 CHROME W/BRASS UNDERBODY (NOT SHOWN)

**8" 3-Handle Deck-Mount Diverter w/ One Piece Brass Underbody**



0374422 J27 CHROME

**8" 2-Handle Deck-Mount Garden Tub Filler w/ Brass Body & Brass Stems**



0374419 J30 CHROME

**8" 2-Handle In-Wall Tub Filler w/ One Piece Brass Underbody**



J224AF CHROME

**8" 2-Handle In-Wall Shower Valve w/ Brass Underbody & Brass Stems**



J 174F CHROME

## SHOWER KITS

**60" Vinyl All Purpose Shower Hose & Head w/ Bracket**

0378803 X -APS60-W WHITE  
X-APS60-B BISCUIT



**60" Vinyl All Purpose Shower Hose & Head w/ Bracket**

X-APS60-N NICKEL  
X-APS60-ORB OIL RUB BRONZE



**Head Arm Flange**

HAF-C CHROME  
HAF-N NICKEL  
HAF-ORB OIL RUB BRONZE



**Air Infused 2.0GPM Airjet Shower Head w/ Vacuum Valve Technology**

Watersense approved. Saves up to 40% on water usage.

KSAJ-110 WHITE KSAJ-100 BLACK



## LAVATORY DRAINS

**1 1/4" Plastic Lav Drain with Overflow**

0371597 250 CHROME 250N NICKEL 2500RB OIL RUB BRONZE  
0377204 251 CHROME LESS OVERFLOW 251N NICKEL LESS OVERFLOW 2510RB OIL RUB BRONZE LESS OVERFLOW



## EMPIRE FAUCET PARTS

ITEM ID	MFG #	DESCRIPTION
<b>HANDLES</b>		
0375903	CRD-JH	JEWELITE CRYSTAL HANDLES CARDED PAIR 17 PT BROACH
0375911	CRD-LJH	LARGE JEWELITE CRYSTAL HANDLES CARDED PAIR 17 PT BROACH
	CRD-UCCH	ULTRA TEAPOT HANDLE - CHROME
	CRD-UCJH	SMOKED CRYSTAL HANDLES CARDED PAIR
	CRD-UCNN	ULTRA TEAPOT HANDLE - NICKEL
	CRD-UCORB	ULTRA TEAPOT HANDLE - OIL RUB BRONZE
	CRD-UJH	ULTRA CRYSTAL HANDLES CARDED PAIR
0375908	HDLBT-C	COLD BUTTON F/JEWELITE HANDLES 375903
0375909	HDLBT-H	HOT BUTTON F/JEWELITE HANDLES 375903
0375901	PAIRS	DOLPHIN TYPE HANDLES, PAIR
0377161	U-JH	JEWELITE CRYSTAL HANDLES PAIR 17 PT BROACH
0375904		REPLACE HANDLE FOR SINGLE LAV FAUCET
0375910		SCREW F/SINGLE HANDLE
<b>STEM &amp; BONNETS</b>		
	CRD-UCSB	ULTRA TEAPOT CARDED PAIR 1/4 TURN WASHERLESS
	CRD-USB	ULTRA CRYSTAL CARDED PAIR 1/3 TURN WASHERLESS
0374407	CRD-GTSB	G. TUB CARDED PAIR 17 PT BROACH 3/4 TURN COMPRESSION F/374412
0374409	CRD-LKSB	LAV & KITCHEN CARDED PAIR 17 PT BROACH 3/4 TURN COMPRESSION
0378594	CRD-TSSB	TUB & SHOWER CARDED PAIR 17 PT BROACH 3/4 TURN COMPRESSION
0375899		RH F/DOLPHIN TYPE HANDLE
0375900		LH F/DOLPHIN TYPE HANDLE
0377162	U-WSB	ULTRA WASHERLESS STEM AND BONNET
<b>RENEWABLE SEATS</b>		
0374410	CRD-LKRS	LAVATORY AND KITCHEN CARDED PAIR
0378599	CRD-TSGRS	TUB & SHOWER CARDED PAIR
		CENTER DIVERTER NIPPLE
0378819	CRD-CDNCS	FOR CONCEALED SHOWER RISER
	CRD-CDNES	FOR EXPOSED SHOWER RISER
0378596	CRD-DS2700	CENTER STEM FOR 2-VALVE DIVERTER 378603
<b>SHOWER KITS</b>		
0374408	CRD-HAF	HEAD ARM FLANGE - CHROME
	CRD-HAF-C	HEAD ARM FLANGE CARDED - CHROME
	CRD-HAF-N	HEAD ARM FLANGE CARDED - NICKEL
	CRD-HAF-ORB	HEAD ARM FLANGE CARDED - OIL RUB BRONZE
	CRD-HAF-W	HEAD ARM FLANGE CARDED - WHITE
0374395	CRD-SAFLT	1/2 IN SHOWER ARM W/FLANGE CARDED
<b>SHOWER HEADS</b>		
0378802	CRD-1/2 SH	ASB SHOWERHEAD 1/2 INLET CARDED-CHROME
0378801	CRD-3/8 SH	ASB SHOWERHEAD 3/8 INLET CARDED-CHROME
<b>TUB/SHOWER SPOUTS</b>		
0375913	ADS	1/2" AUTOMATIC DIVERTER SPOUT BULK-CHROME F/378811
0374423	GTS	8" ABS GARDEN SPOUT - CHROME

ITEM ID	MFG #	DESCRIPTION
0377163	U-ADS	ULTRA 1/2 AUTOMATIC DIVERTER SPOUT BULK - CHROME
	OTS	1/2" OVERRIM TUB SPOUTS BULK - CHROME
<b>KITCHEN SPOUTS</b>		
	8GSN	METAL PLATED GOOSE NECK SPOUT-BULK NICKEL
0378617	8RS	METAL PLATED HIGH RISE RAINBOW SPOUT BULK - CHROME
	8RSN	METAL PLATED HIGH RISE RAINBOW SPOUT BULK - NICKEL
0378616	CRD-8KDS	ABS D-SPOUT W/AERATOR CARDED-CHROME
0378615	CRD-8KDS-M	REPLACE SPOUT F/8IN BRASS EMPIRE FAUCET
	CRD-8KDS-N	ABS D-SPOUT W/AERATOR CARDED-NICKEL
<b>FLANGES AND REPAIR KITS</b>		
	CRD-LKNT	1/2" IPS TWIST ON LOCKNUT CARDED PAIR NON-METALLIC
0378601	CRD-TE	THREADED ESCUTCHEONS 1" -20 THREADED CARDED PAIR -CHROME
	95RKBR	SERVICE KIT
<b>LAVATORY DRAINS</b>		
	300	METAL 1/2 LAV DRAIN W/ OVERFLOW CHR
	350	METAL LAV DRAIN W/OVERFLOW CHR
	300N	METAL 1/2 LAV DRAIN W/ OVERFLOW BN
	350N	METAL LAV DRAIN W/OVERFLOW BN
	350ORB	METAL LAV DRAIN W/OVERFLOW ORB
<b>MISCELLANEOUS PARTS</b>		
0375915	14	UNICA ADAPTER F/4" 2-VALVE DIVERTER 378606
0378826	68SPT-EXT	EXTENSION TUBE F/ 2 VALVE DIVERTER
0374411	CRD-MXT	MIXING TEE F/374412
0374406	HSEJ29	REPLACE HOSE F/374412 J29 GARDEN FILLER
	SLBR-ORB	SIDE BAR W/ SOAP DISH BRONZE

## EMPIRE FAUCET DISPLAYS

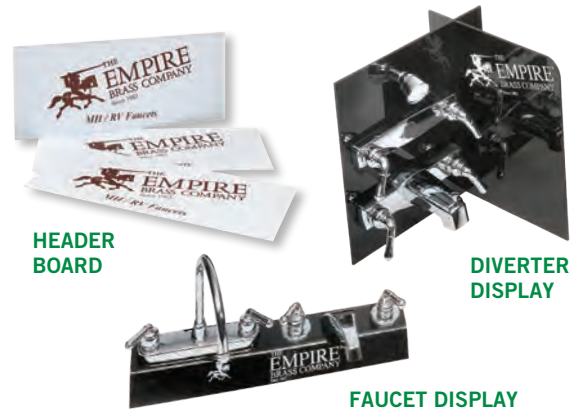

0374594 EMPIRE BRASS HEADER BOARD, 10"H X 24"W

0374595 EMPIRE BRASS DIVERTER DISPLAY. FAUCETS NOT INCLUDED.

0374596 EMPIRE BRASS LAVATORY & KITCHEN FAUCET DISPLAY. FAUCETS NOT INCLUDED.



## 8" KITCHEN FAUCET



0379014 BOX; 12/CTN.

## 8" TUB/SHOWER DIVERTER



Non metallic, Offset Backset.

- 0379016 WITH SHOWER HEAD; 20/CTN.
- 0379017 WITHOUT SHOWER HEAD
- 0376810 DIVERTER KNOB

## 4" TUB/SHOWER



0379006 24/CTN.



0379008 SHOWER ONLY 24/CTN.

## 4" LAVATORY FAUCET



4" centerset chrome faucet. Less pop-up assembly. Box; 24/Ctn.

- 0379012 CLEAR HANDLES
- 0379013 SMOKED HANDLES

## 4" LAV-A-SHOWER



Anti-syphon hook-up for personal shower. Chrome w/ Clear Handles

0379010 BOXED, 24/CTN.

## UTOPIA REPLACEMENT PARTS

### Stem & Bonnet Kit

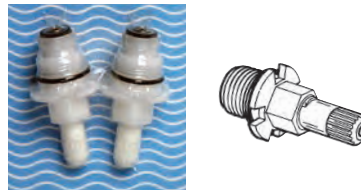

For all Utopia faucets with flat washer. 2/Card;12/Ctn.

- 0376811
- 0375923 - STOP FOR STEM AND BONNET

### Utopia Faucet Repair Kit



Kit includes parts most commonly needed for field repairs of Utopia faucets:

0375918

### Faucet Buttons

f/Utopia Faucets. Small, clear handle buttons.



- 0375917 "H" HOT
- 0375916 "C" COLD

### Faucet Handles



Clear Handles with buttons and screws. 2/Card

- 0375905 CLEAR
- 0375906 SMOKED
- 0375924 KNOB FAUCET HANDLE SCREWS

### Female Aerator

0375920



## 8" TWO HANDLE KITCHEN FAUCET



Chrome Finish

- Acrylic Round Handles
- Washerless Cartridges
- Max Flow Rate 2.2 GPM(8.4LPM) at 60 PSI (ASME.A112.18.1)

0374402 BRASS FAUCET ONLY, NO SPRAY

0374400 BRASS FAUCET WITH SPRAY

0378003 PLASTIC; WITH SPRAY

0378012 REPLACEMENT SPOUT FOR PLASTIC FAUCET

0378013 REPLACEMENT SPOUT FOR BRASS FAUCET

0378010 REPL. CARTRIDGE

0378011 REPL. "CRYSTAL" HANDLE

## 8" SINGLE LEVER KITCHEN FAUCET



Chrome Finish

- Metal Lever Handle
- Stainless Steel Ball Valve
- Max Flow Rate 2.2 GPM(8.4LPM) at 60 PSI (ASME.A112.18.1)

0374432 WITH BLACK SIDE SPRAY

0374431 LESS SIDE SPRAY

## TUB-SHOWER DIVERTER

Chrome-plated plastic body, quarter turn cartridge. Acrylic handles. UPC Approved.

0378008 TUB-SHOWER

0378007 SHOWER ONLY

0378010 REPL. CARTRIDGE

0378011 REPL. ACRYLIC "CRYSTAL" HANDLE



## KITCHEN SPRAY

0374394 HOSE AND SPRAY

0374393 HAND SPRAY ONLY



## REPLACEMENT SPOUT

0378013 FOR 8" BRASS FAUCET

0378012 FOR 8" PLASTIC FAUCET

## BRASS HOSE BIBB

Cast brass male hose bibb. 3/4" hose.

0374463 1/2"

0374464 3/4"



## FREEZELESS WALL FAUCET

Stainless steel, will not wire draw. Adjustable flange pivots to flush with any wall. Adjustable packing nut with teflon impregnated packing. Modern handle fits with precision spline; can be used as loose key. Nozzle 3/4" male hose thread. 10".

0378662 10"-3/4" MIPX1/2" FIP

0378663 10"-1/2" MIPX1/2" C



## ANTI-SIPHON FROST-PROOF SILL COCK

Chrome-plated, silver-soldered. 1/2".

0378670 8"

0378671 10"

0378672 12"





## PRESSURE REGULATOR

### Cash-Acme EB-45 Compact

Fully pressure-balanced piston, automatically reduces and regulates high inlet pressures down to 45 psi at standard factory setting. Built-in back pass check which operates independently of the regulator, allowing water to flow back through the regulator in cases of thermal expansion caused by hot water heating devices. Iron body, threaded connections, iron spring chamber, brass piston and seat ring. EP rubber seat disc and diaphragm and a inbuilt brass strainer screen.



0451003 3/4"

## BLACKLINE WATER HOSES

650 pound burst test pressure, solid brass fittings, tasteless and odorless. Withstands freezing. May be hooked up underground. Thermostatically controlled heat tape is recommended in winter.



0440101 15' BLACK; 20/CTN

0440102 25' BLACK; 13/CTN

## POW-R WRAP

- Water activated fiberglass wrap
- Heat resistant, permanent repair
- Holds up to 600 PSI
- Safe for drinking Water system repairs
- Works on virtually all pipe and hoses

0270600 2" X 48" TO REPAIR UP TO 1" DIAMETER PIPE  
0270601 3" X 132" TO REPAIR FROM 1/4" TO 3" DIA. PIPE



## HOSE CLAMPS



0262500 1/4" - 5/8"

0262501 1/2" - 1-1/8"

0262502 1-7/8" - 3-3/4"

0262503 3-1/8" - 5"

## HOSE WASHER & FILTERS



0379500 FILTER WASHER; 3/CARD

## 1/2 TURN WASHING MACHINE VALVES

Long shank MIP valve with easy on/off control and color-coded handles. Forged brass construction eliminates porosity problems of traditional cast valves. UPC and CSA listed.

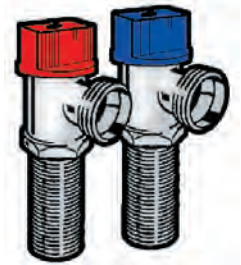

0376905 BLUE HANDLE

0376906 RED HANDLE

## WASHING MACHINE VALVE

One-piece 1/2" brass body with 2.5" tailpiece. Combination .5 solder or threaded connection with locknut. 6/ctn

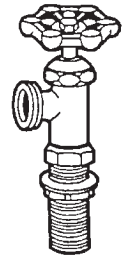

0379915

## OUTLET BOX



**lambro**

Universal for right- or left-hand drain. Rust-proof, beige. Holes 3" apart.

**OS:** 11-3/4" W x 10" H x 2-1/2" D.

**Cutout:** 9-1/8" W x 7-1/4" H x 2-1/2" D.

0440206

## REPAIR COUPLINGS

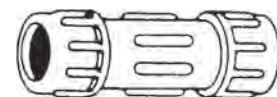

For galvanized & plastic pipe.

0163210 1/2"; 28/CTN

0163209 3/4"; 15/CTN



## ABS-DWV FITTINGS

### FLUSH BUSHING



0321602 1.5" X 1.25"; 50/CTN.  
0321616 2" X 1.5"; 25/CTN.  
0321603 3" X 1.5"; 15/CTN.  
0321617 3" X 2"; 20/CTN.

### HUB SANITARY TEE



h x h x h

0321612 1.5"; 50/CTN.  
0321618 2"; 25/CTN.  
0320808 3"; 25/CTN.  
0320817 4"; 5/CTN.  
0320814 3" X 3" X 1.5"; 20/CTN.  
0321619 3" X 3" X 2"; 20/CTN.

### PIPE INCREASER REDUCER



h x h

0321705 1.5" X 2"; 25/CTN.  
0321817 3" X 1.5"; 25/CTN.  
0321818 3" X 2"; 25/CTN.  
0321819 3" X 4"; 10/CTN.

### MALE ADAPTER



h x mpt

0321611 1.5"; 50/CTN.  
0321816 3"; 25/CTN.

### FEMALE ADAPTER



h x fpt

0321862 1.5"; 100/CTN.  
0321610 3"; 35/CTN.

### CLEANOUT PLUG

0320825 2"; 25/CTN.  
0320812 3"; 30/CTN.

mpt



### COUPLING

0321601 1.5"; 100/CTN.  
0321812 2"; 25/CTN.  
0320807 3"; 48/CTN.  
0320818 4"; 10/CTN.

h x h



### CLEANOUT ADAPTER W/PLUG

0320815 1.5"; 50/CTN.  
0320819 4"; 10/CTN.  
0320822 3"; 25/CTN.

mpt



spg x fpt



### FITTING C.O. ADAPTER

0321822 2"; 25/CTN.  
0321823 3"; 25/CTN.  
0321825 4"; 10/CTN.

spg x fpt



### VENT ELBOW

0321846 3"; 25/CTN.

h x h



### DOUBLE TEE FITTING

0321855 3"; 5/CTN.

h x h x h x h



## ABS-DWV FITTINGS

### 1/16 BEND



0320799 3"; 30/CTN.

### WYE

0321836 3"  
0321837 2"  
0321838 1-1/2"

h x h x h



### 1/8 BEND



0321604 1.5"; 50/CTN.  
0320828 2"; 25/CTN.  
0320816 3"; 25/CTN.  
0320821 4"; 10/CTN.

### LONG SWEEP, 1/4 BEND

0320827 1.5"; 25/CTN.  
0320826 3"; 25/CTN.  
0320820 4"; 5/CTN.

h x h



### 1/8 BEND STREET



0320921 3"; 20/CTN.

### 2-WAY CLEANOUT TEE

0321622 3"



### 1/4 BEND



0321605 1.5"; 50/CTN.  
0321858 2"; 75/CTN.  
0320810 3"; 25/CTN.

### LONG-TURN TEE

0321827 1.5"; 20/CTN.  
0321828 2"; 25/CTN.  
0321850 3"; 15/CTN.  
0321829 3" X 3" X 1-1/5"; 10/CTN.  
0321830 3" X 3" X 2"; 10/CTN.  
0321851 4"; 5/CTN.

h x h x h



### 1/4 BEND STREET



0320920 3"; 20/CTN.

### DOUBLE 1/4 BEND

0321857 3"; 10/CTN.

h x h x h



### FPT 1/4 BEND



0320811 3" H X 3" FPT; 30/CTN.

### DOUBLE SANITARY TEE

0321623 3"; 10/CTN.  
0320813 3" X 3" X 2" X 1.5"; 10/CTN.  
0321620 3" X 3" X 2" X 2"; 10/CTN.

h x h x h x h



## PVC-DWV SCHEDULE 40 FITTINGS

### 45° STREET ELL

Used to change direction from a fitting hub to a pipe. Sometimes called a "street eighth bend."  
20/Ctn.



0321496 3"  
0321526 1.5"

### 22-1/2° ELBOW

Hub x hub. Sometimes called a "sixteenth bend."



0321530 3"

### MALE ADAPTER

Hub x MIP. Adapts to standard female pipe threads. Teflon thread tape is recommended for threaded joints.

0321522 1.5"; 50/CTN.  
0321492 3"; 25/CTN.



### FEMALE ADAPTER

Hub x FIP. Adapts to standard male pipe threads. Teflon thread tape is recommended for threaded joints.

0321524 1.5"; 25/CTN.  
0321493 3"; 20/CTN.

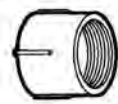

### FITTING CLEANOUT BODY

Solvent welds into fitting hub and adapts to male threaded plug. Teflon thread tape is recommended for threaded joints.  
SPIGOT X FIP

0321552 3"

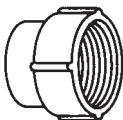

### 90° SANITARY STREET ELBOW

Hub x spigot. Used to change direction. Sometimes called a "street quarter bend."

0321511 1.5"; 50/CTN.  
0321512 2"; 30/CTN.  
0321523 3"; 20/CTN.



### 45° ELBOW

Hub x hub. Used to change direction in piping. Sometimes called an "eighth bend."

0321506 1.5"; 50/CTN.  
0321498 3"; 20/CTN.  
0321487 4"



### CLEANOUT PLUG

MIP. Used to form a removable closure. Threaded plugs offer a corrosion proof alternative to metal plugs. Teflon thread tape is recommended for threaded joints.

0321491 3"; 75/CTN.

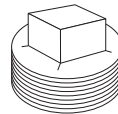

### COUPLING

Hub x hub. Used to join straight lengths of pipe.

0321518 1.5"; 40/CTN.  
0321517 2"; 30/CTN.  
0321490 3"; 50/CTN.  
0321485 4"

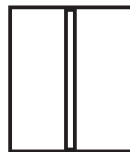

### REDUCING COUPLING

Hub x hub. Used to reduce or increase pipe sizes.

0321515 3" X 1.5"; 30/CTN.  
0321514 3" X 2"; 25/CTN.  
0321516 2" X 1.5"; 30/CTN.

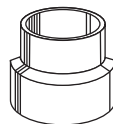

### 90° SANITARY ELBOW

Hub x hub. Used to change direction in piping. Sometimes called a "quarter bend."

0321509 1-1/2"; 50/CTN.  
0321510 2"; 30/CTN.  
0321497 3"; 20/CTN.  
0321488 4"; 20/CTN.



### WYE

Hub x hub x hub. Used when connecting a branch line into a horizontal drain pipe. Also can be used in conjunction with a "Twist-Lok" plug to provide a cleanout in a drain pipe.

0321504 1.5"; 50/CTN.  
0321513 2"; 20/CTN.  
0321499 3"; 10/CTN.



### TEST TEE

With plug. Used at the base of a vertical drain pipe (stack) to provide a cleanout opening flush with the finished wall. Teflon thread tape is recommended for threaded joints.

0321500 3"

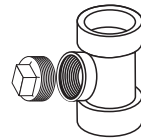

### SANITARY TEE

Hub x hub x hub. Used with connecting a branch line into a vertical drain pipe (stack).

0321508 1.5"; 50/CTN.  
0321507 2"; 30/CTN.  
0321494 3"; 15/CTN.  
0321810 3" X 3" X 2"; 10/CTN.



### LONG TURN TEE

H X H X H  
0320789 3"



# PVC SCHEDULE 40 PRESSURE PIPE FITTINGS

## DOUBLE SANITARY TEE

Hub x hub x hub x hub.



0321811 3"; 10/CTN.

## TEE

Slip x slip x slip. Used to provide a branch supply line from a main line. 25/Ctn.

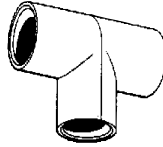

0320912 3/4"  
0320932 1/2"

## COUPLING

Slip x slip. Used to join lengths of pipe. S x S; 50/Ctn.

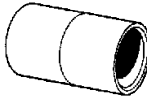

0320904 3/4"

## CHECK VALVE

0440420 3/4" SOCKET

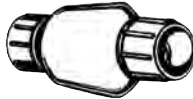

## 90° STREET ELBOW

Slip x MIP. Used to change direction in piping. Adapts to standard female pipe threads. Teflon joint tape is recommended for threaded joints.



0320918 3/4" S X MIP

## 90° ELBOW

Slip x slip. Used to change direction in piping.



0320916 3/4" S X S; 25/CTN.  
0320931 1/2" S X S; 25/CTN.

## 2-WAY CLEANOUT TEE

4" H x H x H. Used with a vertical pipe stack, this fitting provides for above ground level access to piping.

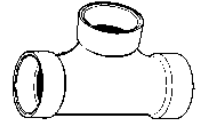

0321486

## 45° ELBOW

Slip x slip. Used to change direction in piping. 3/4"; 25/Ctn.



0320914

## FEMALE ADAPTER

Slip x FIP. Adapts Genova pressure pipe to standard male pipe threads. Teflon joint tape is recommended for threaded joints.

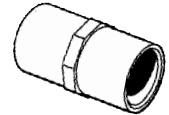

0320906 3/4"; 25/CTN.  
0320928 1/2"; 25/CTN.

## MALE ADAPTER

Slip x MIP. Adapts Genova pressure pipe to standard female pipe threads. Teflon joint tape is recommended for threaded joints.

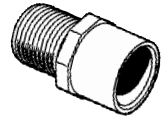

0320908 3/4"; 25/CTN.  
0320929 1/2"; 25/CTN.

## SOCKET END BALL VALVE

0440415 3/4"; 10/CTN.  
0440416 1/2"; 10/CTN.



## MISCELLANEOUS PLUMBING FITTINGS

### BALL VALVE

Forged brass, 3/4".

0440451 BRASS; 10/CTN.



### CHECK VALVE

Brass with stainless steel rings. 3/4" FPT x 3/4" MPT.

0451612 BRASS; 50/CTN.



### CHECK VALVE

Brass 200 lb. WOG (1500F), non-shock, swing check, bronze disc, threaded ends. 3/4" FPT.

0375360 BRASS; 80/CTN.



### LONG HANDLE BALL VALVE

0168221 1/2" INSERT X 1/2" INSERT BRASS

0168222 3/4" INSERT X 3/4" INSERT BRASS



### 3/4" FPT GATE VALVE

0375358 BRASS; 100/CTN.



### 1/4" TURN BALL VALVE

1/2" Insert x 1/2" Insert Brass

0168220



### STOP WASTE GLOBE VALVE

3/4"; 202T0A

0440700 BRASS



### GALVANIZED ADAPTER

0167072 1/2" MPT ; 50/CTN.

0167073 3/4" B X MPT



### BRASS BOILER DRAIN MPT VALVE

0375356 3/4"; BRASS; 144/CTN.

0379962 1/2"; BRASS; 10/CTN.

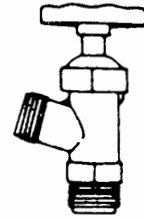

### LEAD FREE BARB STOP

1/2" x 3/8" OD Compression straight stop (Quarter Turn). Lead Free

0168218 12/CTN

### GALVANIZED NIPPLE



0167090 3/4" X 3"; 25/CTN.

0167092 3/4" X 4"; 25/CTN.

0167093 3/4" X CLOSE; 25/CTN.

## CASH-ACME DUAL BACKFLOW PREVENTER

Keeps polluted water from contaminating potable water by preventing reverse flow into supply lines.

Protects the primary water system (city water supply) by providing containment at the water meter. Valves function in either horizontal or vertical position and under continuous or intermittent pressure. Maximum system pressures to 175 psi and minimum pressure of 10 psi. Temperatures from 32° F to 140° F. Maximum recommended rate of flow is 30 GPM. 3/4" valve has a female threaded union inlet and a female threaded outlet. Straight-through design minimizes pressure drop. Certified under A.S.S.E. Standard 1024.

0440475 17217LF LEAD FREE

### Installation Tip:

Backflow preventer valve should be installed immediately downstream of the water meter. The valve may be installed horizontally or vertically.

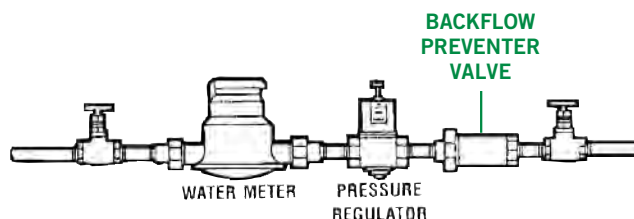

SHOWN ABOVE: Typical installation where inlet pressure exceeds 150 psi: the pressure regulator must be installed ahead of the dual check backflow preventer.



## BARBED FITTINGS

### CONNECTOR



0441630 3/4"; 10/CTN.

### ADAPTER

MPT; 25/Ctn.



0440208 3/4"

### PIPE HOSE BARBS



0441628 3/4" X 3/4" FPT; 15/CTN.

## QEST FITTINGS

Qest standard pipe threaded, compression fittings for repair or add-on to any kind of existing plumbing—galvanized, copper & CPVC.

### TEES

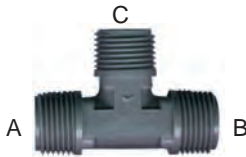

STOCK #	A	B	C	QTY.
0166020	1/2"	1/2"	1/2"	50/CTN.
0166021	3/4"	3/4"	1/2"	50/CTN.
0166022	3/4"	3/4"	3/4"	50/CTN.
0166023	3/4"	1/2"	3/4"	50/CTN.
0166025	3/4"	1/2"	1/2"	50/CTN.
0166027	1/2"	1/2"	3/4"	50/CTN.
0167044	1"	1"	1"	10/CTN.
0167046	1"	1"	3/4"	10/CTN.
0167048	1"	3/4"	1"	10/CTN.
0167049	1"	3/4"	1/2"	10/CTN.
0167050	1"	3/4"	3/4"	10/CTN.
0166090	1"	1"	1/2"	10/CTN.

### STREET ELBOWS

1/2" F. 50/CTN.  
0166096 1/2" M  
0166097 3/4" M



### NUTS



0166052 3/8" OD, 1/4" ID, 1/2" FPT; 100/CTN.  
0166053 1/2" OD, 3/8" ID, 1/2" FPT; 100/CTN.  
0166054 5/8" OD, 1/2" ID, 3/4" FPT; 100/CTN.  
0167060 7/8" OD, 3/4" ID, 1" FPT; 25/CTN.

### NUT, RING & CONE KIT



Each kit contains 100 nuts, cones & rings. Flare nuts for both 3/8" OD and 1/2" OD tubing have 1/2" thread size fittings. Flare nuts for 5/8" OD tubing have 3/4" standard pipe threads to fit 3/4" thread size fittings.

0166070 3/8" OD, 1/4" ID  
0166071 1/2" OD, 3/8" ID  
0166072 5/8" OD, 1/2" ID

### TEST CAPS

0166040 1/2" F  
0166037 3/4" F



100/Ctn.

### TEST PLUGS

0166094 1/2" M  
0166095 3/4" M



100/Ctn.

### MALE COUPLINGS



0166030 1/2" X 1/2"; 100/CTN.  
\*0166033 3/4" X 3/4"; 50/CTN.  
\*0166035 3/4" X 1/2"; 50/CTN.  
\*0167058 1" X 1"; 25/CTN.  
\*0167059 1" X 3/4"; 25/CTN.  
\*0166091 1" X 1-1/2"; 25/CTN.

\* 3/8" & 1/4" standard pipe thread adapts to pumps & appliances

### ELBOWS



\*0166024 1/2" X 1/2"; 100/CTN.  
\*0166026 1/2" X 3/8"; 100/CTN.  
\*0166029 3/4" X 3/4"; 50/CTN.  
\*0167052 1" X 1"; 25/CTN.  
\*0167054 1" X 3/4"; 25/CTN.

\* 3/8" & 1/4" standard pipe thread adapts to pumps & appliances

### CONES



0166055 3/8" OD, 1/4" ID; 100/CTN.  
0166056 1/2" OD, 3/8" ID; 100/CTN.  
0166057 5/8" OD, 1/2" ID; 100/CTN.  
0167064 7/8" OD, 3/4" ID; 25/CTN.

## QEST FITTINGS - CONTINUED

### MALE/FEMALE ADAPTERS

0167056 3/4" M X 1/2" F; 50/CTN.  
0167057 1" M X 3/4" F; 50/CTN.



### FEMALE COUPLINGS

0166039 3/4" F X 3/4" F; 50/CTN.  
0166044 1/2" F X 1/2" F; 100/CTN.

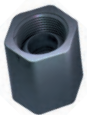

### STRAIGHT STOP VALVE

10/Ctn.  
0440620 1/2" F X 1/2" M  
0440622 1/2" M X 1/2" M  
0166111 3/4" M X 1/2" M



### DROP EAR ELBOWS

0166098 1/2" M X 1/2" F; 50/CTN.  
0166099 3/4" M X 1/2" F; 50/CTN.



### DRAIN VALVE

10/Ctn.  
0166112 1/2" F X HT  
0440626 1/2" M X HT  
0166113 3/4" M X HT



### GLOBE VALVE

10/Ctn.  
0440632 3/4" M X 3/4" M



### WATER LINE CLAMPS

0166105 5/8" OD, 1/2" ID;  
100/CTN.



### ANGLE STOP VALVE

0166109 1/2" M X 1/2" M;  
10/CTN.



### RINGS

100/Ctn.  
0166058 FOR 3/8" OD, 1/4" ID  
0166059 FOR 1/2" OD, 3/8" ID  
0166060 FOR 5/8" OD, 1/2" ID  
50/Ctn.  
0167062 FOR 7/8" OD, 3/4" ID



## UPONOR PEX-A TUBING

Uponor PEX is the clean, green and healthy alternative — no solder, nor torches, no fluxes or solvents. All connections are made with engineered fittings that, when properly installed, are leak-resistant and will last the life of the system.

Uponor PEX is lightweight and flexible, requiring substantially fewer fittings than copper or rigid-plastic systems, so it installs more easily and efficiently.

Approved for hot and cold water applications. The most freeze resistant pex plumbing available. Replaces galvanized, copper or cpvc water lines without soldering or glues. Recommended for potable water systems. Purchase in coils or straight sticks. If using pipe outdoors, it must be buried or sleeved to protect from uv light.

Produced by the peroxide (Engel) method. This method performs "hot" cross-linking, above the crystal melting temperature. It provides more consistent and uniform cross-linking than the other two methods, and is somewhat more flexible in cold weather applications.



SDR-9 plumbing tubing meets ASTM F 876, ASTM F 877 and CSA B137.5 specifications. Pressure rating: 160psi 73.4 deg F, 100psi 180 deg F, 80psi @ 200 deg F.

0165109 3/8" ID X 5'  
0165111 1/2" ID X 5'  
0165112 1/4" ID X 5'  
0165106 3/4" ID X 20'

0165105 1/2" ID X 20'  
0165102 3/4" ID X 100'  
0165101 1/2" ID X 100'  
0165100 3/8" ID X 100'

## BESTPEX PEX-B TUBING

Meets csa b137.5, Nsf 14, 61, astm f 876, f 877 and upc standards. 160 Psi @ 73.F deg. F, 100 psi @ 180 deg. F, 80 psi @ 200 deg. F. Approved for hot and cold water applications. Replaces galvanized, copper or cpvc water lines without soldering or glues. Recommended for potable water systems. Purchase in coils or straight sticks. Available in red, white or blue colors to allow easy

identification of hot or cold water lines. If using pipe outdoors, it must be buried or sleeved to protect from uv light.



0165115 1/2" X 20' BLUE  
0165116 1/2" X 20' RED  
0165118 3/4" X 20' BLUE

0165117 3/4" X 20' RED  
0165107 1/2" X 100' BLUE  
0165108 1/2" X 100' RED



## UNIVERSAL FITTINGS

### REDUCING COUPLING

Joins 1/2" PEX, copper or CPVC tubing to 3/8" PEX, copper or CPVC tubing.

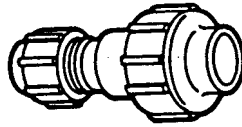

0166212 1/2" ID - 5/8" OD" X 1/4" ID - 3/8" OD; 20/BOX

### REDUCING TEE

Used to provide a branch from a main line and is designed to join to PEX, copper or CPVC tubing. 3/4" ID - 7/8" OD" x 3/4" ID - 7/8" OD" x 1/2" ID - 5/8" OD; 10/Box.

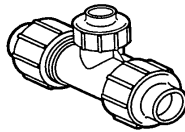

0166211

### COUPLING

Designed to join PEX, copper or CPVC tubing.

0166202 1/4" ID - 3/8" OD"; 20/BOX

0166203 1/2" ID - 5/8" OD"; 20/BOX

0166204 3/4" ID - 7/8" OD"; 20/BOX

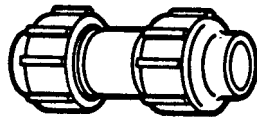

### MALE ADAPTER

Designed to adapt from metal female pipe thread to PEX, copper or CPVC tubing on the COLD WATER SIDE ONLY of a hot and cold water supply system. Where hot or changing temperatures are likely, utilize the recommended Genova Universal Transition Male Adapter in conjunction with a Genova Universal Coupling. Teflon tape is the accepted method of sealing pipe threads on CPVC fittings. Do not use other materials or compounds unless specifically approved by the manufacturer.

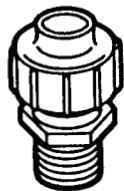

0166207 1/2" ID - 5/8" OD"; 20/BOX

0166208 3/4" ID - 7/8" OD"; 20/BOX

### REDUCING ASSEMBLY

Allows any fitting hub to be reduced to accept PEX, copper or PVC tubing. Used where line is reduced in size.

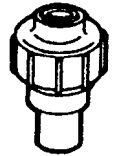

0166222 3/4" ID - 7/8" OD" X 1/2" ID - 5/8" OD; 10/BOX

0166223 1/2" ID - 5/8" OD" X 3/8" ID - 1/2" OD; 10/BOX

### TEE

This fitting is used to provide a branch from a main line and is designed to join with to PEX, copper or CPVC tubing.

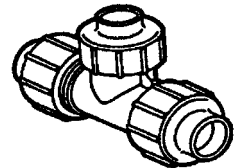

0166209 1/2" ID - 5/8" OD"; 10/BOX

0166210 3/4" ID - 7/8" OD"; 10/BOX

### 90° ELBOW

Used to change the direction in piping and is designed to join with to PEX, copper or CPVC tubing.

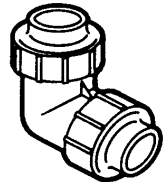

0166213 1/2" ID - 5/8" OD"; 20/BOX

0166214 3/4" ID - 7/8" OD"; 10/BOX

### 90° SWIVEL ELBOW

Allows a direct 90° connection between 5/8" OD PEX, copper or CPVC tubing and male running threads on faucet. Has a cone washer inside female end to achieve seal.

HAND TIGHTEN ONLY! This fitting seals by means of a gasket and the use of joint compound or Teflon tape is neither necessary nor recommended.

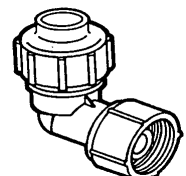

0166215 1/2" ID - 5/8" OD"; 20/BOX

## FEMALE ADAPTER

Designed to adapt from metal male pipe thread to PEX, copper or CPVC tubing.

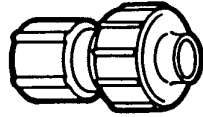

HAND TIGHTEN ONLY! This fitting seals by means of a gasket and the use of joint compound or Teflon tape is neither necessary nor recommended.

0166205 1/2" ID - 5/8" OD"; 20/BOX

0166206 3/4" ID - 7/8" OD"; 20/BOX

## ICE MAKER KIT

Kit consists of a 5/8" OD tee and 1/4" OD valve assembly for use in hooking up any appliance served by 1/4" OD tubing.

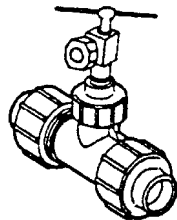

0166220

## ALL PURPOSE SEAL LUBRICANT

Used as a lubricant with Genova Universal fittings for ease in application.  
1 oz.

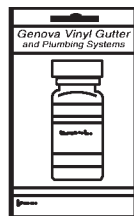

0180102

## LINE VALVE

This unique valve mechanically joins water supply tubing utilizing a special locking ring and an elastomeric seal. It can be used to join PEX, copper or CPVC tubing. 10/Box.

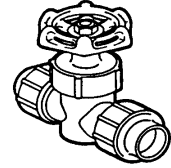

0166200 5/8" ID - 1/2" OD"

0166201 3/4" ID - 7/8" OD"

## STRAIGHT SUPPLY VALVE

Adapts mechanically and is used where toilet, vanity or sink water supply piping comes through the wall. Designed to join PEX, copper or CPVC tubing. 10/Box.

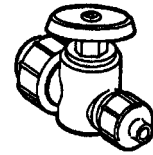

0166224 1/2" ID X 5/8" OD" X 1/4" ID

## METAL GRIPPER RINGS

For replacement purposes in Genova's Universal Fittings. 2 gripper rings of each size are included in each bag: 1/4", 1/2", 3/4" OD; 20/Box/



0166221

**IMPORTANT:**

Note the order in which each of the component parts are installed in the Universal Fitting hand-tightened nut. Be sure all parts are present and in this order before installing.

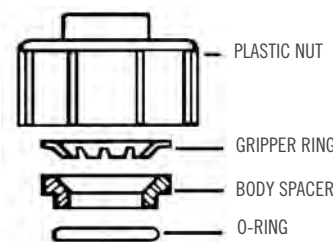

## CPVC FITTINGS

### SWIVEL ELBOW W/ SOLVENT WELD SOCKET

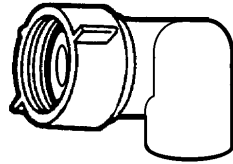

Allows a direct 90° connection between CPVC tubing and female running threads on faucet. Has a cone washer inside female end to achieve seal.

0166135 1/2" X 3/4" FPT

### STOP ANGLE VALVE

CPVC x OD Compression

0166130 1/2" X 3/8"



### MALE ADAPTER

0166101 1/2"  
0166124 3/4"

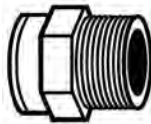

### FEMALE ADAPTER

0166102 1/2"  
0166123 3/4"



### STOP STRAIGHT VALVE

CPVC x OD Compression

0166131 1/2" X 3/8"



## TEES

0166117 1/2"  
0166118 3/4"  
0166120 3/4" X 3/4" X 1/2"

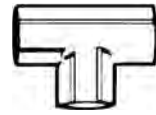

## 45° ELBOWS

0166133 3/4"

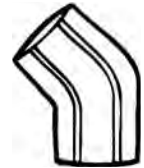

## 90° ELBOWS

0166115 1/2"  
0166116 3/4"



## COUPLINGS

0166121 1/2"  
0166122 3/4"

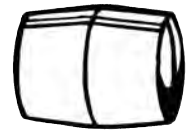

## REDUCING BUSHING

Used to reduce from fitting socket to CPVC tubing.

0166134 3/4" X 1/2"

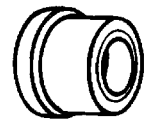

## STOP & WASTE

0166127 CPVC X CPVC 1/2"  
0166128 CPVC X CPVC 3/4"



## SWIVEL ADAPTER

0166136 1/2" X 3/4"

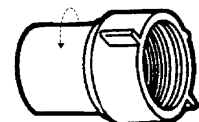



## FAILSAFE FITTINGS FOR PEX

Fail Safe components are NOT interchangeable with polybutylene or any other insert and crimp components even though they have been designed for use with the same crimp tools and gauges.

This insert and crimp system is designed to help a professional plumber make permanent, tightly sealed, leakproof connections in a properly-functioning PEX hot and cold water distribution system or to repair any existing system.

### BRASS TEST PLUG

- 0168223 1/2" INSERT; 100/CTN.
- 0168224 3/4" INSERT; 50/CTN.



### TRANSITION COUPLINGS

- 0168216 1/2" PB X 1/2" PEX; 100/CTN.
- 0168217 3/4" PB X 3/4" PEX; 100/CTN.



### CRIMPING TOOL



- 0168107 FOR 1/2" TUBING

### SWIVEL ELBOW

- 1/2" x 1/2" FPT Brass Nut;
- 25/Ctn.

- 0168233

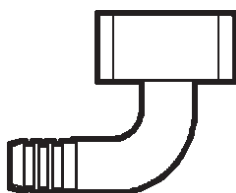

### INSERT TEES

Insert x insert x insert.

- 0168214 1/2" X 1/2" X 1/2" TEE; 25/CTN.
- 0168215 3/4" X 3/4" X 3/4" TEE; 25/CTN.
- 0168248 1/2" X 1/2" X 3/4" REDUCER; 25/CTN.
- 0168249 3/4" X 1/2" X 1/2" REDUCER; 25/CTN.
- 0168250 3/4" X 1/2" X 3/4" REDUCER; 25/CTN.
- 0168251 3/4" X 3/4" X 1/2" REDUCER; 25/CTN.

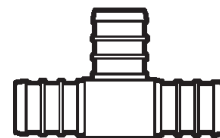

### INSERT COUPLERS

- 0168204 1/2" X 3/8"; 100/CTN.
- 0168205 1/2" X 1/2"; 100/CTN.
- 0168206 3/4" X 1/2"; 50/CTN.
- 0168207 3/4" X 3/4"; 50/CTN.



### INSERT ELBOWS

Insert x insert.

- 0168210 1/2" X 1/2" ELBOW; 50/CTN.
- 0168211 3/4" X 1/2" ELBOW; 50/CTN.
- 0168212 3/4" X 3/4" ELBOW; 20/CTN.

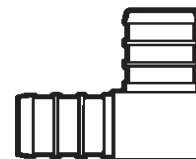

### BLACK COPPER CRIMP RINGS

- 0168200 FOR 3/8" TUBING; 100/CTN.
- 0168201 FOR 1/2" TUBING; 100/CTN.
- 0168202 FOR 3/4" TUBING; 100/CTN.

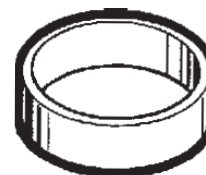

## FAILSAFE FITTINGS FOR PEX - CONTINUED

### BALLCOCK NUT

Fits 1/4" & 3/8" Riser.

0168227 100/CTN.



### CONE SEALS (WASHERS)

1/2" ID Lav cone. 100/Bag

0168259

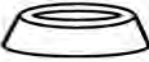

### FLARE SWIVEL ADAPTERS

1/2" Insert x 1/2" Flare; 50/Ctn.

0168235

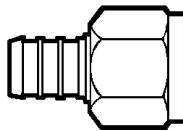

### FPT ADAPTERS

25/Ctn.

0168242 1/2" INSERT X 1/2" FPT

0168243 1/2" INSERT X 3/4" FPT

0168244 3/4" INSERT X 3/4" FPT

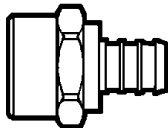

### MPT ADAPTERS

0168237 1/2" INSERT X 1/2" MPT

0168238 1/2" INSERT X 3/4" MPT

0168239 3/4" INSERT X 1/2" MPT

0168240 3/4" INSERT X 3/4" MPT

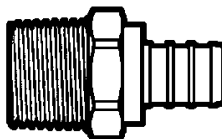

### FEMALE SWIVEL ADAPTERS

0168256 3/4" INSERT X 3/4" FPT; 50/CTN.

0168257 1/2" INSERT X 1/2" FPT; 50/CTN.

0168258 1/2" INSERT X 1/2" CLOSET; 10/PK.

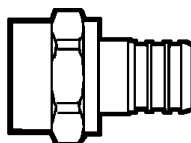

### DROP EAR ELBOW

1/2" Insert x 1/2" MPT.

0168246 10/CTN.



### CENTERSET NUTS

Fits 3/8" riser (1/2" hole). 100/Ctn.

0168226



### BRASS STRAIGHT STOP VALVE

0168220 1/2" INSERT X 1/2" INSERT; 10/CTN.

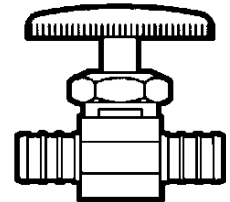

### FLOWGUARD GOLD 1-STEP CPVC CEMENT



Oatey's one-step cement for CPVC is specially formulated to bond with FlowGuard Gold CPVC where all-purpose cements will not. Needs no primer, faster cure time than regular cements, low VOC, meets ASTM D-2846 & F-4 93. Exceeds environmental requirements.

0112630 4 OZ.; 24/CTN

0112631 8 OZ.; 24/CTN



FOR PEX

Throw away your crimping tools, solvent cement, torches, solder and Teflon tape—you won't need them with the Flair-It plumbing system, designed for normal hot and cold potable water applications. Extremely simple to install and reusable. Resists corrosion and scaling, with high resistance to cold temperatures. Complies with ASTM D 3309 standard.

### Installation Tips

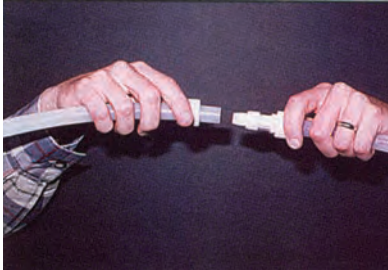

1. Slide nut over tubing

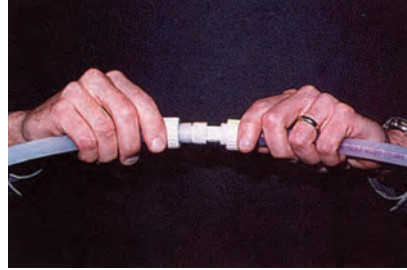

2. Firmly press tubing onto the flare of the fitting



3. Slide the nut to threads and hand tighten securely onto the fitting.

### TEE

W/three Flair-It connections.

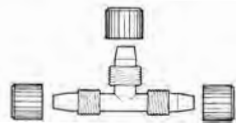

	L	X	R	X	INSIDE
0164320	1/2"	ID X	1/2"	ID X	1/2" ID
0164322	3/4"	ID X	1/2"	ID X	1/2" ID
0164323	3/4"	ID X	1/2"	ID X	3/4" ID
0164324	3/4"	ID X	3/4"	ID X	1/2" ID

	L	X	R	X	INSIDE
0164325	3/4"	ID X	3/4"	ID X	3/4" ID
0164326	1/2"	ID X	1/2"	ID X	3/8" ID
0164327	3/8"	ID X	3/8"	ID X	3/8" ID
0164328	1/2"	ID X	1/2"	ID X	1/2" MPT

### PEX ADAPTER AND WASHERS

PEX adapter to gray poly pipe.



0164415	3/4" PB X 3/4" PEX
0164412	1/2" WASHER, 10/BAG.

### DRAIN ANGLE VALVE

A drain valve with Flair-It connections on both ends.

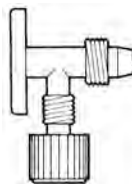

0164380	1/2" ID X 1/2" ID
---------	-------------------

### COMPRESSION ANGLE VALVE

0164373	1/2" X 3/8"
---------	-------------



### ELBOWS

W/Flair-It connections on both ends.

0164300	1/2" ID X 1/2" ID
0164301	1/2" ID X 3/4" ID
0164302	3/4" ID X 3/4" ID
0164303	3/8" ID X 3/8" ID

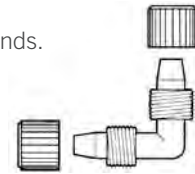

Flair-It connection x FPT.

0164305	1/2" ID X 1/2" FPT
0164306	3/4" ID X 3/4" FPT

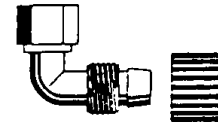

Flair-It connection x MPT.

0164307	1/2" ID X 1/2" MPT
0164308	3/4" ID X 1/2" MPT
0164309	3/4" ID X 3/4" MPT
0164310	1/2" ID X 3/8" MPT

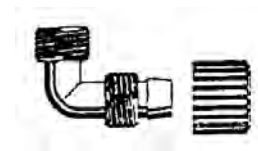

### SWIVEL ELBOW

Faucet connection to Flair-It connection.

0164316	3/4" ID X 3/4" FPT
0164317	1/2" ID X 3/4" FPT
0164318	3/8" ID X 1/2" FPT
0164315	1/2" ID X 1/2" FPT

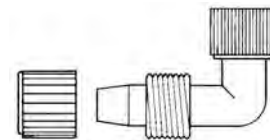

### COMPRESSION STOP VALVE

0164372	1/2" X 3/8"
---------	-------------





## FOR PEX - CONTINUED

### COUPLING & ADAPTER

W/Flair-It connections on both ends.

- 0164336 1/2" ID X 1/2" ID
- 0164337 1/2" ID X 3/4" ID
- 0164338 3/4" ID X 3/4" ID
- 0164339 1/2" ID X 3/8" ID
- 0164340 3/8" ID X 3/8" ID

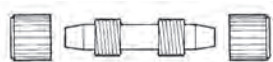

Adapters w/female pipe threads and a Flair-It connection.

- 0164341 1/2" ID X 1/2" FPT
- 0164342 3/4" ID X 3/4" FPT
- 0164344 1/2" ID X 3/4" FPT

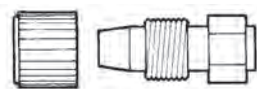

Couplings w/male pipe threads and a Flair-It connection.

- 0164346 1/2" ID X 1/2" MPT
- 0164348 1/2" ID X 3/8" MPT
- 0164351 1/2" ID X 3/4" MPT
- 0164352 3/8" ID X 1/2" MPT
- 0164347 3/4" ID X 3/4" MPT

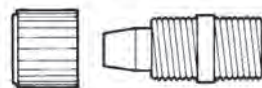

### STRAIGHT STOP VALVE

Flair-It connections on both ends.

- 0164375 3/8" ID X 3/8" ID
- 0164376 1/2" ID X 1/2" ID
- 0164371 1/2" P X 1/2" MPT
- 0164377 3/4" ID X 3/4" ID

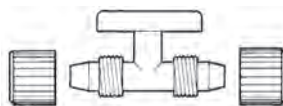

### SWIVEL TEE

W/female pipe thread swivel in the middle.

- 0164333 1/2" ID X 1/2" ID X 1/2" FPT

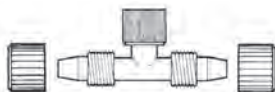

### SWIVEL STRAIGHT

Faucet connection to a Flair-It connection.

- 0164356 3/4" ID X 3/4" FPT
- 0164357 3/8" ID X 1/2" FPT
- 0164358 1/2" ID X 3/4" FPT
- 0164355 1/2" ID X 1/2" FPT

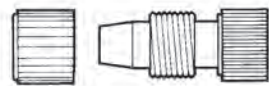

### GARDEN HOSE FITTING

Garden hose to a Flair-It connection.



- 0164360 SWIVEL COUPLING 1/2" ID X 3/4" FPT

### PLUG

Used to cap-off Flair-It fittings.

- 0164368 3/8" ID X 3/8" ID
- 0164369 1/2" ID X 1/2" ID
- 0164370 3/4" ID X 3/4" ID

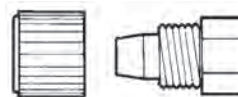

### TRANSITION COUPLING

- 0164332 3/4" POLY X 3/4" PEX

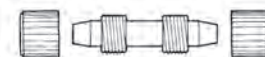

### DROP EAR ELBOW

Shower & tub connection to Flair-It connection.

- 0164304 1/2" ID X 1/2" FPT

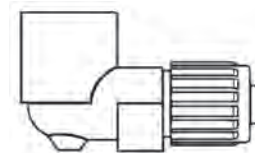

### CAP

Used to insert a plug into the end of a pipe.

- 0164366 1/2" ID X 1/2" ID
- 0164367 3/4" ID X 3/4" ID



### WASHING MACHINE VALVE

- 0164404 1/2 ID



### 3-WAY VALVE

- 0164397 1/2" P X 1/2" P X 1/2" P





## FOR PEX - CONTINUED

### SWIVEL BALLCOCK ADAPTER

Toilet connection to a Flair-It connection.

- 0164359 1/2" ID X 3/4" FPT
- 0164361 3/8" ID X 3/4" FPT



### DISHWASHER HOOK-UP KIT

Each kit contains one each:

- Straight Stop Valve, 1/2" P x 1/2P"
- Male Elbow, 1/2" P x 3/8" MPT with Tapered Threads
- Tee, 1/2" P x 1/2" P x 1/2" P

0164390

### FLAIR-IT WRENCH

Molded wrench allows you to reach small, hard-to-access places.

- 0381500 3/8" & 1/2"
- 0381501 1/2" & 3/4"



### FLAIR-IT ICEMAKER VALVE & TEE

Use with polybutylene pipe. Due to copper valve, teflon tape is recommended. Sold separately.

- 0164374 VALVE ONLY
- 0164330 TEE ONLY



## FLAIR-IT DEALER STARTER KITS

### 1/2" Dealer Starter Kit

Each kit contains the following in a corrugated box:

	QTY
Tee . . . . .	1/2 P x 1/2 P x 1/2 P . . . 10
Elbow . . . . .	1/2 P x 1/2 P . . . . . 20
Coupling . . . . .	1/2 P x 1/2 P . . . . . 20
Male Pipe Adapter . . . . .	1/2 P x 1/2 MPT. . . . . 20
Tee . . . . .	1/2 P x 1/2 P x 3/8 P . . . 10
Straight Stop Valve . . . . .	1/2 P x 1/2 FPT Swivel . . 10
Elbow Swivel . . . . .	1/2 P x 1/2 FPT Swivel . . 10
Cap . . . . .	1/2 FPT . . . . . 10
Female Pipe Adapter (nuts included) . . . . .	1/2 P x 1/2 FPT . . . . . 10

0164383

### Mixed Dealer Starter Kit

Each kit contains the following in a corrugated box:

	QTY
Elbow . . . . .	1/2 P x 1/2 P . . . . . 10
Drop Ear . . . . .	1/2 P x 1/2 FPT . . . . . 10
Swivel Elbow . . . . .	1/2 P x 1/2 FPT . . . . . 10
Tee . . . . .	1/2 P x 1/2 P x 1/2 P . . . 10
Tee . . . . .	1/2 P x 1/2 P x 3/8 P . . . 10
Coupling . . . . .	1/2 P x 1/2 P . . . . . 10
Female Adapter . . . . .	1/2 P x 1/2 FPT . . . . . 10
Male Adapter . . . . .	1/2 P x 1/2 MPT. . . . . 10
Coupling . . . . .	3/4 P x 1/2 P . . . . . 10
Swivel Straight . . . . .	1/2 P x 1/2 FPT Sw . . . 10
Elbow . . . . .	3/4 P x 3/4 P . . . . . 10
Tee . . . . .	3/4 P x 1/2 P x 1/2 P . . . 10
Tee . . . . .	3/4 P x 3/4 P x 1/2 P . . . 10
Tee . . . . .	3/4 P x 3/4 P x 3/4 P . . . 10
Coupling . . . . .	3/4 P x 3/4 P . . . . . 10
Ball Adapter . . . . .	1/2 P x 3/4 BCT Sw . . . 10
Straight Valve . . . . .	1/2 P x 1/2 P . . . . . 10
PB Adapter . . . . .	3/4 P x 3/4 P . . . . . 10
PEX Tubing . . . . .	3/8" x 5' . . . . . 10
PEX Tubing . . . . .	1/2" x 5' . . . . . 10
PEX Tubing . . . . .	3/4" x 5' . . . . . 10
PEX Tubing . . . . .	1/2" x 100' . . . . . 1
4 Drawer Bin . . . . .	(263136) . . . . . 2
5 Drawer Bin . . . . .	(263135) . . . . . 2
Header Card . . . . .	. . . . . 1

0164386

### FLAIR-IT POSTER



0263137

FOR TILT BINS, SEE PAGE 210.



## PROLINE PLASTIC PUSH FITTINGS

- Universal fitting for use with any tube from metallic to soft vinyl - including copper, PEX & CPVC
- Approved for behind the wall use
- Low Lead Compliant
- Polysulfone Fittings
- Twist & lock for secure connection
- No tools or locking clip needed
- Reusable & installs in seconds
- Fittings & bags color coated by size
- NSF 61 Approved



STOCK NO.	MFG'S NO.	DESCRIPTION	CTN QTY
0161550	640-133HC	1/2 COUPLING	10
0161551	640-143HC	3/4X1/2 COUPLING	5
0161552	640-144HC	3/4 COUPLING	10
0161553	640-433HC	1/2 MIP ADAPTOR	10
0161554	640-434HC	1/2X3/4 MIP ADAPTOR	10
0161555	640-444HC	3/4 MIP ADAPTOR	5
0161556	640-633HC	1/2 FIP ADAPTOR	10
0161557	640-634HC	1/2X3/4 FIP ADAPTOR	10
0161558	640-644HC	3/4 FIP ADAPTOR	5
0161559	640-803HC	1/2 FIP SWIVELL ADAPTOR	10
0161560	641-133HC	1/2 ELBOW	10
0161561	641-143HC	1/2X3/4 ELBOW	10
0161562	641-144HC	3/4 ELBOW	5
0161563	641-333HC	1/2 MIP ELBOW	10
0161564	641-433HC	1/2 FIP ELBOW	10
0161565	641-733HC	1/2 DROPEAR ELBOW	10
0161566	642-333HC	1/2 TEE	10
0161567	642-444HC	3/4 TEE	5
0161568	643-003HC	1/3 ENDCAP	10
0161569	643-004HC	3/4 ENDCAP	10
0161570	644-133HC	1/2 STRAIGHT VALVE	5
0161571	644-144HC	3/4 STRAIGHT VALVE	3

## TILT BINS



Transparent, tilt-out multi-purpose storage system, free-standing or wall-mountable. Bins are removable. Bin tags included. Two sizes available. Unique interlocking design lets you mix and match rows of 4- and 5-drawer bins.



0263135 5 DRAWERS WITH TAGS



0263136 4 DRAWERS W/TAGS

## SHARKBITE® PUSH-FIT FITTINGS



SharkBite® push-fit fittings allow the user to connect pipe in seconds with relative ease.

- Fits copper tubing, and CTS CPVC and PEX: Connects all three types in any combination.
- Instant push-fit connection for increased ease-of-use: No soldering, clamps, unions, or glue required.
- Fittings certified to 200 PSI and 200°F (93°C).
- Integral tube liner for PEX installations: Integrated design means no loose components, ensures reliable connection.
- Design certified to ANSI/NSF-61 and ASSE 1061 product standard for use in potable water
- Approved to be used underground and behind walls without access panels.



STOCK NO.	MFG'S NO.	DESCRIPTION
0161500	U008LF	1/2X1/2 STRAIGHT COUPLING
0161501	U016LF	3/4X3/4 STRAIGHT COUPLING
0161521	U006UF	3/8X3/8 STRAIGHT COUPLING
0161519	U058LF	3/4X1/2 REDUCING COUPLING
0161525	U009LF	3/8X1/2 REDUCING COUPLING
0161526	U060LF	1X3/4 REDUCING COUPLING
0161502	U072LF	1/2X1/2 FNPT CONNECTOR
0161503	U088LF	3/4X3/4 FNPT CONNECTOR
0161504	U120LF	1/2X1/2 MNPT CONNECTOR
0161505	U134LF	3/4X3/4 MNPT CONNECTOR
0161517	U068LF	1/2X3/4 FNPT CONNECTOR
0161518	U116LF	1/2X3/4 MNPT CONNECTOR
0161506	U248LF	1/2X1/2 ELBOW
0161514	U256LF	3/4X3/4 ELBOW
0161520	U274LF	3/4X1/2 ELBOW
0161522	U246LF	3/8X3/8 ELBOW
0161507	U362LF	1/2X1/2X1/2 TEE
0161515	U370LF	3/4X3/4X3/4 TEE
0161523	U360LF	3/8X3/8X3/8 TEE
0161530	U444LF	3/4X1/2X3/4 TEE
0161531	U454LF	3/4X1/2X1/2 TEE
0161516	U412LF	3/4X3/4X1/2 REDUCING TEE
0161508	U514LF	1/2 END STOP
0161509	23037-0000LF	1/2 X 3/8COMP STRAIGHT STOP
0161510	U712	DISCONNECT CLIP 3/4
0161511	U710	DISCONNECT CLIP 1/2
0161524	U708	DISCONNECT CLIP 3/8
0161512	22222-0000LF	1/2X1/2 BALL VALVE
0161513	22185-0000LF	3/4X3/4 BALL VALVE
0440012	U3088FLEX24LF	3/4IN PUSH-ON WTR HTR CONN 24IN

# ANDERSON METALS - COPPER & BRASS FITTINGS

## FLARE NUTS, LONG



0160322 3/8"  
0160333 1/2"

## HEAVY FORGED NUTS



0168015 3/8"

## SWIVEL CONNECTORS



0162751 0162752

## MALE ADAPTER INSERT



0161375 3/4"

## FLARE TO MPT COUPLINGS



0161022 3/8" FL X 3/8" MPT  
0161037 1/2" FL X 3/4" MPT

## FLARE SEALING CAPS



0160221  
0160232

## FLARE/FLARE UNIONS



0160522 3/8"

## FLARE TO FPT ELBOWS



0161235 1/2" FL X 3/4" FPT

## CLOSE NIPPLE



0161367 3/4"

## FLARE TO FPT COUPLINGS



0160922 3/8" FL X 1/2" FPT  
0160923 3/8" FL X 3/4" FPT  
0160936 1/2" FL X 3/4" FPT

## SWIVEL FLARE NUT COUPLINGS



0161921 3/8" FL X 3/8" FL  
0161932 1/2" FL X 1/2" FL

## REDUCING FLARE UNION

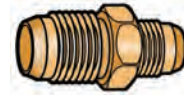

0160631 1/2" X 3/8"; 25/CTN.

## HEX NIPPLE



0161326 3/4"

## COPPER TUBING

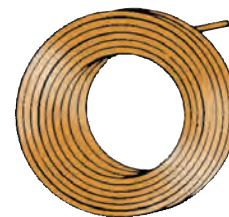

0165121 3/8 OD, 50'  
0165132 1/2 OD, 50'  
0165133 5/8 OD, 50'

## WATERRISE® WATER SHUT-OFF

- Premade to save you time and money
- Self-contained in tough PVC case
- Insulation and heating cable protect against the cold
- All copper pipe and rugged Mueller valves
- 5-year guaranteed replacement of parts or complete unit
- American made
- Self-draining
- Surface shut-off

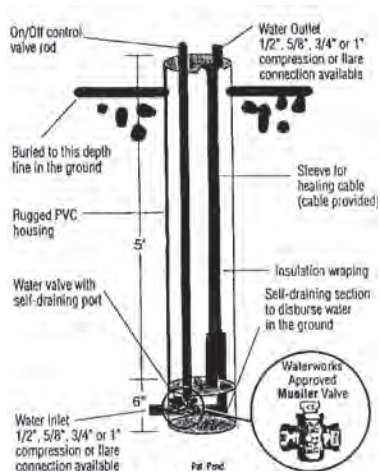

SPECIAL ORDER ONLY

## BRUSHES

- 0112617 1-1/2"; 36/CTN
- 0112618 3"; 12/CTN



## BOSS BIGGIES ABRASIVE WIPES

Dual sided abrasive wipes clean paint, adhesives, oils and more from hands, tools and surfaces. 80 wipes / tub

0181401



## RACHET-STYLE PIPE CUTTER

Easily cuts through PVC pipe up to 1". Ratchet-action requires minimal pressure. Molybdenum stainless steel blade will not rust or break and lasts twice as long as most other cutters.



- 0380250 CUTTER
- 0380251 REPLACEMENT BLADES

## PIPE THREAD TAPE

Chemically inert, withstands alkalis, acids, oil and solvents. Temperature range: -400°F to -600°F. 1/2" x 260". 200/ctn



0360410

## PIPE & TUBE HANGER STRAPS

### PLATED STEEL HANGER STRAPS W/HOLES:

Sturdy steel strapping with alternating bolt & nail holes. 3/4" wide.

- 0262602 3/4" X 100'; 5/CTN
- 0262604 3/4" X 10'; 25/CTN



### PLASTIC HANGER STRAPS W/HOLES:

3/4" plastic strapping, non-corrosive w/holes. Packed in dispenser box.

- 0262600 3/4" X 50'; 20/CTN
- 0262601 3/4" X 100'; 20/CTN



## OETIKER CLAMP MASTER RATCHET PINCHERS

It is imperative that all Oetiker eared clamps be closed according to specifications in order to be 100% effective. Oetiker's Clamp Master Ratchet Pinchers are light in weight, but with a heavy-duty action that provides the needed leverage to close the ears on the stainless steel clamps.

0380255



## OETIKER STEPLESS™ EAR CLAMPS

For those hard to get to places for a sure no-leak repair or installation. The patented "step-less" design provides a 360° seal around the pipe. 100/ctn

- |                |                 |
|----------------|-----------------|
| <b>FOR PEX</b> | <b>FOR POLY</b> |
| 0167063 3/8"   | 0167069 1/2"    |
| 0167065 1/2"   | 0167070 3/4"    |
| 0167066 3/4"   |                 |



## ALL PURPOSE CEMENT

Heavy-bodied clear cement for use on ABS, PVC, and CPVC pipe and fittings up to 12" in diameter. Flows freely and provides a thick layer. Helps fill gaps in larger diameter pipe and joints.

- 0112609 4 OZ.; 24/CTN
- 0112610 8 OZ.; 24/CTN
- 0112615 16 OZ.; 24/CTN



## FLOWGUARD GOLD 1-STEP CPVC CEMENT

Oatey's one-step cement for CPVC is specially formulated to bond with FlowGuard Gold CPVC where all-purpose cements will not. Needs no primer, faster cure time than regular cements, low VOC, meets ASTM D-2846 & F-4 93. Exceeds environmental requirements.

- 0112630 4 OZ.; 24/CTN
- 0112631 8 OZ.; 24/CTN



## ABS-TO-PVC TRANSITION GREEN CEMENT

Medium-bodied green-colored cement for use in joining ABS to PVC in non-pressure transition joints. All schedules up to 6" dia. pipe and fittings. Recommended application temperature 40°F to 110°F. Meets ASTM D-3138.

- 0112623 4 OZ 24/CTN
- 0112613 16 OZ.; 6/CTN



## PLUMBER'S PUTTY

Fixture setting compound for setting frames, faucets, strainer baskets, etc. Stays flexible, will not crack or shrink. Easily workable, soft, pliable material. Not for use on marble, granite, plastic or any other dimensional stone. Meets Military Spec TTP-1536A.

- 0112645 24/CTN



## ABS CEMENT

Medium-bodied black cement for use on ABS pipe and fittings up to 6" in diameter. For all pressure and non-pressure applications.

- 0112619 4 OZ.; 24/CTN
- 0112612 16 OZ.; 24/CTN
- 0112620 8 OZ.; 24/CTN
- 0112621 32 OZ.; 12/CTN



## PVC CEMENT

Regular-bodied clear cement for PVC pipe and fittings up to 3" dia. Use on Schedule 40 and Schedule 80 potable water pressure pipe, gas, conduit, drain waste and vent pipe. Flows freely, sets-up quickly. Apply at temperatures 40° - 90° F. NSF and UPC approved. Exceeds ASTM D-2564.

- 0112614 4 OZ.; 24/CTN
- 0112608 32 OZ. 12/CTN



## COLD WEATHER CEMENT

Medium bodied clear cement for use on PVC pipe and fittings up to 6" dia. Formulated for fast initial set up at temperatures down to -5° F to 100° F Sch. 40 and Sch. 80. Non-pressure, DWV, up through 4" diameter, no primer needed where local codes permit.

Recommended for all grades and types of PVC pipe and fittings, potable water, pressure pipe, gas, conduit and DWV. Meets ASTM D-2564.

- 0112625 PINT; 24/CTN



## RAIN-R-SHINE

Fast-setting blue PVC cement for solvent welding under damp or wet conditions; effective when quick pressurization is needed. Ideal for sprinkler or pool installations.

- 0112607 16 OZ.; 24/CTN



## PURPLE PRIMER/CLEANER

All purpose primer/cleaner for PVC/CPVC pipe and fittings. Purple tint tells you primer has been used. Removes surface dirt, grease and grime; also softens pipe surface to allow for a fast and permanent solvent weld. Flows freely, evaporates quickly.

- 0112616 8 OZ.; 24/CTN
- 0112622 32 OZ.; 12/CTN



## CLEAR CLEANER

A clear cleaner recommended for use on ABS, PVC and CPVC pipe and fittings, all schedules and diameters. A fast-acting cleaner to remove surface dirt, grease and grime. Flows freely and evaporates quickly. Apply at temperatures 40°F to 100°F.

- 0112640 8 OZ.; 24/CTN



## PIPE JOINT COMPOUND

Non-toxic, fast-set, non-hardening paste lubricates and seals threaded joints. Use on water, natural gas, steam and air lines.

- 0112801 2 OZ. TUBE; 12/CTN
- 0112901 4 OZ. WITH BRUSH; 12/CTN





## EASYHEAT<sup>®</sup>

EasyHeat custom pipe freeze protection at off-the-reel prices! Choose pre-packaged systems or for longer cable needs, just cut off the required length from the reel dispenser and attach plug, packaged separately. Freeze-Free uses a self-regulating conductive core that reacts to changes in temperature, needing no thermostat. Patented fused plug — the same quality connector used by the industry since 1992 — installs in minutes with basic household tools. Approved for use on both plastic and metal to -20° F. UL listed.

## CAMCO ANTIFREEZE

Protect your potable water system from freeze damage. Camco antifreezes inhibit fouling and corrosion while preventing algae growth. They also help in lubricating pumps and valves throughout the system. Choose a temperature-specific product designed for your winterizing needs. Safe and tasteless.



- 0190602 FREEZE BAN -50
- 0190601 WINTER BAN -50
- 0190603 ARCTIC BAN -50 (PG/ETHYL ALCOHOL BLEND)

## BLOW OUT PLUGS

To remove water from lines, screw into water intake fitting and apply air pressure.



- 0192010 PLASTIC; 50/CTN
- 0192011 BRASS; 50/CTN

## HAND PUMP

Easily, economically installs anti-freeze. One end of adapter hose fits over faucet; pump fits into anti-freeze bottle with other end of tube over pump inlet.



- 0192005 10/CTN



## THERMOSTAT



- 35°F Automatic "On"
- 45°F Automatic "Off" (approx.)
- Controls any 120 volt heater, heating cables, engine heaters, electric heaters, heat lamps

No special wiring, easy to install—just plug it in. Reduces energy consumption. One outlet with an indicator light to let you know unit is functioning. 1800 watts maximum, 15 amps, 120 volts.

0272318

NOTE: Use on specific voltage only; make sure electrical outlet is not overloaded.

## FREEZE CUT-TO-LENGTH CABLE



- 0272305 100' REEL
- 0272306 300' REEL
- 0272304 500' REEL



## FUSED PLUG KITS



- Grounded 30" cord-set requires less heating cable
- Power indicator light shows that power gets to the plug and indicates an intact fuse
- Pipe mounting brackets for easy attachment to typical water pipes
- Built-in, fast-reaction fuse
- Easy to install: just insert the cable into the plug and tighten the screws
- Same reliability
- Now supports up to 75 feet of Freeze Free cable
- UL System Listed

0272307 KIT

0272317 KIT; BULK

0272310 END CAPS, 5/BAG; 10/CTN.

## FROST KING FIBERGLASS PIPE INSULATION KIT

Kit, comes with 25' plastic vapor barrier. For either hot or cold water pipes. 3" x 1/2" x 25' roll. 1.6 R-Value. Made In USA.

Package covers 17' of 1/2" Pipe, 12' of 3/4" pipe, 10' of 1" pipe.

0270801



## FROST KING PRE-SLIT TUBULAR

Single step foam pipe insulation with half-slit to easily slip over pipe. Self-closing or self-sealing so no tape is needed. Flexible for easy bending. 6' long, bulk.

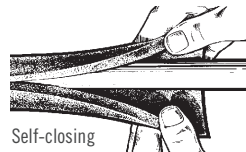

Self-closing

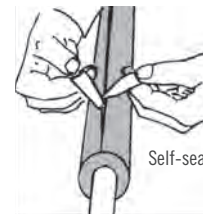

Self-sealing

### SELF-CLOSING

- 3/8" Thick Wall
- 0270525 FOR 1/2" COPPER OR 1/4" IRON PIPES
- 0270526 FOR 3/4" COPPER OR 1/2" IRON PIPES
- 0270527 FOR 1-1/4" COPPER OR 1" IRON PIPES
- 3/4" Thick Wall - R 5.1
- 0270528 FOR 1/2" COPPER PIPES
- 1" Thick Wall - R 6.4
- 0270495 FOR 1" COPPER PIPES

### SELF-SEALING

- 1/2" Thick Wall Self Sealing - Brown
- 0270523 FOR 1/2" COPPER OR 1/4" IRON PIPES
- 0270524 FOR 3/4" COPPER OR 1/2" IRON PIPES
- Self Sealing Rubber Tubular
- 0270522 3/4" ID X 3/4" WALL